

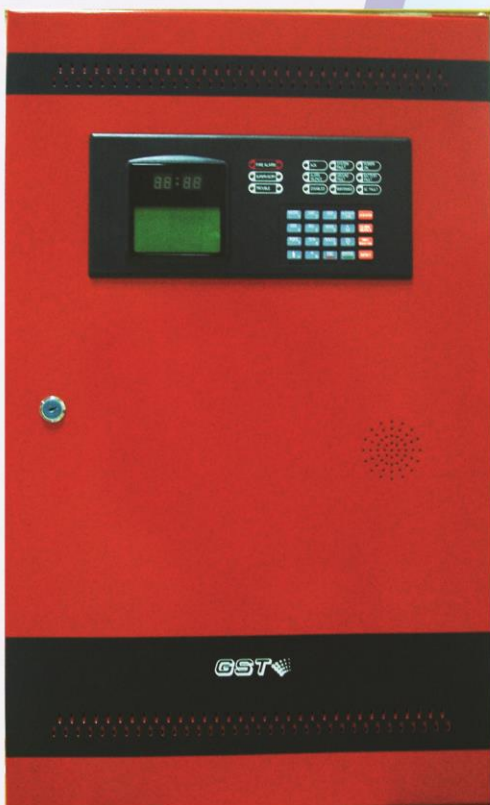

GST-M200

Intelligent Fire

Alarm Control Panel



Installation and Operation Manual

Issue 1.10 August 2017
ERP: 30307512

CONTENTS

Fire Alarm System Limitations	1
Installation Precautions	3
1 Product Description	5
1.1 Features and Options	5
1.2 Technical Specifications.....	6
1.3 Controls and Indicators.....	8
1.3.1 LCD Display	8
1.3.2 LED Indicators	8
1.3.3 Control and Indicating Part.....	9
1.3.4 Functional keys	9
1.3.5 Service / Program Keys:	9
1.4 Circuits.....	9
1.5 Components	10
1.6 Peripheral Devices	10
1.6.1 Series Addressable Detectors.....	10
1.6.2 Manual Pull Stations.....	11
1.6.3 Loop Isolators	11
1.6.4 Control Modules.....	11
1.6.5 Synchronization Module and Horn / Strobes Module	11
1.7 Accessories	12
1.8 Getting Started.....	12
2 Installation	12
2.1 Installing the Cabinet	12
2.2 Power	14
2.2.1 AC Power and Earth Ground Connection	14
2.2.2 Battery Power	15
2.3 24VDC Power Output Connection	15
2.4 Relays (For Common Use).....	15
2.5 Notification Appliance Circuits (NAC).....	16
2.6 Signaling Line Circuits (SLC).....	17
2.7 UL Power-limited Wiring Requirements	17
3 Programming	18
3.1 Programming Data Entry	18
3.2 Description of Programming Screens	19
3.3 Programming and Passwords.....	19
3.4 Programming (Master).....	20
3.4.1 System Setup.....	20
3.4.2 Point Debug	24
3.4.3 Point Edit.....	25
3.4.4 Event & Command.....	27
3.5 Autoprogram (Master Password)	30
3.6 Disable / Enable (Maintenance Password).....	30

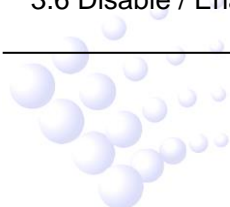

3.7 Walk Test (Maintenance Password).....	31
3.8 Configure Item (Maintenance Password)	32
3.8.1 TIME / DATE	32
3.8.2 LCD Contrast	32
3.8.3 NAC Setup	33
4 Operating Instructions.....	34
4.1 Panel Control Buttons.....	34
4.1.1 <i>ACK/STEP</i> (Maintenance Password).....	34
4.1.2 <i>ALARM SILENCE</i> (Maintenance Password).....	34
4.1.3 <i>DRILL/HOLD 2 SEC</i> (Maintenance Password)	34
4.1.4 <i>Reset</i> (Maintenance Password)	35
4.2 LED Indicators	35
4.3 Normal Operation	35
4.4 Trouble Operation.....	36
4.5 Alarm Operation.....	37
4.6 Waterflow Circuits Operation (For Future Use).....	38
4.7 Supervisory Operation	38
4.8 Coded Operation	39
4.9 Positive Alarm Sequence.....	39
4.10 Walk Test	40
4.11 Read Status	40
4.11.1 View History	40
4.11.2 System Point	41
4.11.3 Event & Command	41
4.11.4 Disable Point.....	42
5 Selecting and Locating Batteries.....	42
5.1 NFPA Battery Requirements	42
5.2 Calculating the Battery Size.....	42
6 Default Programming.....	43
7 Wire Requirements.....	44
8 Menu Operation Guide.....	45
Limited Warranty.....	45
Appendix Basic System Connection.....	47

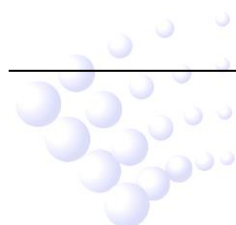

Fire Alarm System Limitations

While a fire alarm system may lower insurance rates, it is not a substitute for fire insurance!

An automatic fire alarm system—typically made up of smoke detectors, heat detectors, manual pull stations, audible warning devices, and a fire alarm control with remote notification capability—can provide early warning of a developing fire. Such a system, however, does not assure protection against property damage or loss of life resulting from a fire.

The Manufacturer recommends that smoke and/or heat detectors be located throughout a protected premise following the recommendations of the current edition of the National Fire Protection Association Standard 72 (NFPA 72), manufacturer's recommendations, State and local codes, and the recommendations contained in installation and operation manual of the detectors, which is made available at no charge to all installing dealers. A study by the Federal Emergency Management Agency (an agency of the United States government) indicated that smoke detectors may not go off in as many as 35% of all fires. While fire alarm systems are designed to provide early warning against fire, they do not guarantee warning or protection against fire. A fire alarm system may not provide timely or adequate warning, or simply may not function, for a variety of reasons:

Smoke detectors may not sense fire where smoke cannot reach the detectors such as in chimneys, in or behind walls, on roofs, or on the other side of closed doors. Smoke detectors also may not sense a fire on another level or floor of a building. A second-floor detector, for example, may not sense a first-floor or basement fire.

Particles of combustion or "smoke" from a developing fire may not reach the sensing chambers of smoke detectors because:

- Barriers such as closed or partially closed doors, walls, or chimneys may inhibit particle or smoke flow.
- Smoke particles may become "cold," stratify, and not reach the ceiling or upper walls where detectors are located.
- Smoke particles may be blown away from detectors by air outlets.
- Smoke particles may be drawn into air returns before reaching the detector.

The amount of "smoke" present may be insufficient to alarm smoke detectors. Smoke detectors are designed to alarm at various levels of smoke density. If such density levels are not created by a developing fire at the location of detectors, the detectors will not go into alarm.

Smoke detectors, even when working properly, have sensing limitations. Detectors that have photoelectric sensing chambers tend to detect smoldering fires better than flaming fires, which have little visible smoke. Detectors that have ionizing-type sensing chambers tend to detect fast-flaming fires better than smoldering fires. Because fires develop in different ways and are often unpredictable in their growth, neither type of detector is necessarily best and a given type of detector may not provide adequate warning of a fire.

Smoke detectors cannot be expected to provide adequate warning of fires caused by arson, children playing with matches (especially in bedrooms), smoking in bed, and violent explosions (caused by escaping gas, improper storage of flammable materials, etc.).

Heat detectors do not sense particles of combustion and alarm only when heat on their sensors increases at a predetermined rate or reaches a predetermined level. Rate-of-rise heat detectors may be subject to reduced sensitivity over time. For this reason, the rate-of-rise feature of each detector should be tested at least once per year by a qualified fire protection specialist. *Heat detectors are designed to protect property, not life.*

IMPORTANT! Smoke detectors must be installed in the same room as the control panel and in rooms used by the system for the connection of alarm transmission wiring, communications, signaling, and/or power. If detectors are not so located, a developing fire may damage the alarm system, crippling its ability to report a fire.

Audible warning devices such as bells may not alert people if these devices are located on the other side of closed or partly open doors or are located on another floor of a building. Any warning device may fail to alert people with a disability or those who have recently consumed drugs, alcohol or medication.

Please note that:

- Strobes can, under certain circumstances, cause seizures in people with conditions such as epilepsy.
- Studies have shown that certain people, even when they hear a fire alarm signal, do not respond or comprehend the meaning of the signal. It is the property owner's responsibility to conduct fire drills and other training exercise to make people aware of fire alarm signals and instruct them on the proper reaction to alarm signals.
- In rare instances, the sounding of a warning device can cause temporary or permanent hearing loss.

A fire alarm system will not operate without any electrical power. If AC power fails, the system will operate from standby batteries only for a specified time and only if the batteries have been properly maintained and replaced regularly.

Equipment used in the system may not be technically compatible with the control panel. It is essential to use only equipment listed for service with your control panel.

The most common cause of fire alarm malfunction is inadequate maintenance. To keep the entire fire alarm system in excellent working order, ongoing maintenance is required per the manufacturer's recommendations, and UL and NFPA standards. At a minimum, the requirements of Chapter 10 of NFPA 72 shall be followed. Environments with large amounts of dust, dirt or high air velocity require more frequent maintenance. A maintenance agreement should be arranged through the local manufacturer's representative. Maintenance should be scheduled monthly or as required by National and/or local fire codes and should be performed by authorized professional fire alarm installers only. Adequate written records of all inspections should be kept.

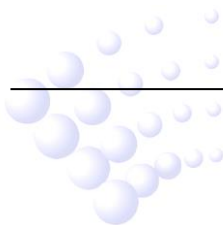



Installation Precautions

Adherence to the following will aid in problem-free installation with long-term reliability:

WARNING - Several different sources of power can be connected to the fire alarm control panel. Disconnect all sources of power before servicing. Control unit and associated equipment may be damaged by removing and/or inserting cards, modules, or interconnecting cables while the unit is energized. Do not attempt to install, service, or operate this unit until this manual is read and understood.

CAUTION - System Reacceptance Test after Software Changes. To ensure proper system operation, this product must be tested in accordance with NFPA 72 Chapter 7 after any programming operation or change in site-specific software. Reacceptance testing is required after any change, addition or deletion of system components, or after any modification, repair or adjustment to system hardware or wiring. All components, circuits, system operations, or software functions known to be affected by a change must be 100% tested. In addition, to ensure that other operations are not inadvertently affected, at least 10% of initiating devices that are not directly affected by the change, up to a maximum of 50 devices, must also be tested and proper system operation verified.

This system meets NFPA requirements for operation at 0-49°C/32-120° F and at 93% RH (non condensing), and applies to be installed in the dry indoor environment.

Like all solid state electronic devices, this system may operate erratically or can be damaged when subjected to lightning-induced transients. Although no system is completely immune from lightning transients and interferences, proper grounding will reduce susceptibility. *Overhead or outside aerial wiring is not recommended, due to an increased susceptibility to nearby lightning strikes.* Consult with the Technical Services Department if any problems are anticipated or encountered.

Disconnect AC power and batteries prior to removing or inserting circuit boards. Failure to do so can damage circuits.

Remove all electronic assemblies prior to any drilling, filing, reaming, or punching of the enclosure. When possible, make all cable entries from the sides or rear. Before making modifications, verify that they will not interfere with battery, transformer, and printed circuit board location.

Do not tighten screw terminals more than 9 in-lbs. Over-tightening may damage threads, resulting in reduced terminal contact pressure and difficulty with screw terminal removal.

Though designed to last many years, system components can fail at any time. This system contains static-sensitive components. Always ground yourself with a proper wrist strap before handling any circuits so that static charges are removed from the body. Use static-suppressive packaging to protect electronic assemblies removed from the unit.

Follow the instructions in the installation, operating, and programming manuals. These instructions must be followed to avoid damage to the control panel and associated equipment. FACP (Fire Alarm Control Panel) operation and reliability depend upon proper installation by authorized personnel.

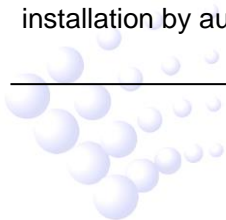

It is imperative that the installer understands the requirements of the Authority Having Jurisdiction (AHJ) and be familiar with the standards set forth by the following regulatory agencies:

- ✧ Underwriters Laboratories Standards
- ✧ NFPA 72 National Fire Alarm Code

Before proceeding, the installer should be familiar with the following documents.

- ✧ **NFPA Standards**
 - NFPA 72 National Fire Alarm Code
 - NFPA 70 National Electrical Code
- ✧ **Underwriters Laboratories Documents:**
 - UL 864 Standard for Control Units and Accessories for Fire Alarm Systems

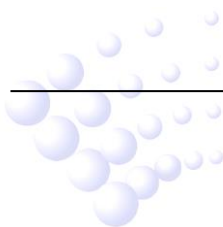

1 Product Description

GST-M200 Intelligent Fire Alarm Control Panel (FACP) complies to UL 864 standard with features of easy installation, operation, and maintenance. All circuit boards are installed in a metal cabinet, providing a complete fire control system for most applications.

Inventory

GST-M200 is delivered with all components installed. When the shipment is received, check to make certain that all accessories have been included:

- ✧ Cabinet key
- ✧ Manual

1.1 Features and Options

- ✧ Single ring loop which meets Style 6 (Class A) requirements or Style 7 (Class A) requirements when utilizing Model C-M9503 Isolators.
- ✧ 240 addressable devices.
- ✧ Notification Appliance Circuit (NAC): Two Style Y (Class B) SOUNDER ports, regulated, rated current 0.001A, maximum current 1.2A. The FACP is able to synchronize all sounders (Max 12) by connecting a synchronization module with each of the two NACs.
- ✧ 2.4A total power for NACs and 0.75A for regulated 24 VDC auxiliary power outputs.
- ✧ 5.3A total system power (includes battery charger).
- ✧ Three fixed relay outputs: Alarm/Fault/Supervisory (for common use).
- ✧ EIA-232 PC interface for GMC communication system - no connection (for future use).
- ✧ RS485 communication interface for networking - no connection (for future use).
- ✧ LCD display unit of 128 x 64.
- ✧ Real-time clock.
- ✧ History file with 1,000 - event capacity.
- ✧ Advanced fire technology features:
 - Maintenance alert by LED indication.
 - Point trouble identification.
- ✧ "Walk test", silent or audible.
- ✧ PAS (Positive Alarm Sequence) per point (NFPA 72 compliant).
- ✧ Auto silence timer option per NAC, the time duration is 5 minutes.
- ✧ Password and key-protected nonvolatile memory.
- ✧ User programmable password.
- ✧ Fully programmable from local keypad.
- ✧ Signaling Line Circuit (SLC) operates up to 4000ft through twisted pair with cross

section 17AWG (1.0mm²).

- ✧ Compatible with GST's series devices:
 - **DI-M9102/I-9102(UL) / JTY-GD-G3 Intelligent Photoelectric Smoke Detector**
 - **DI-M9103/I-9103(UL) / JTW-ZCD-G3N Intelligent Rate of Rise and Fixed Temperature Heat Detector**
 - **DI-M9101 Intelligent Combination Heat Photoelectric Smoke Detector**
 - **DC-M9101 Conventional Combination Heat Photoelectric Smoke Detector**
 - **DC-M9102 Conventional Photoelectric Smoke Detector**
 - **DC-M9103 Conventional Rate of Rise and Fixed Temperature Heat Detector**
 - **C-9314P Passive Remote Indicator**
 - **BP-9314P Back Plate**
 - **DB-M01 Base for DI-M9101, DI-M9102, DI-M9103 , DC-M9102 detectors**
 - **DZ-03 Base**
 - **DI-M9204 Digital Manual Call Point**
 - **DC-M9504 Base Mount Isolator**
 - **C-M9503/C-9503 / GST-LD-8322 Loop Isolator**
 - **DC-M9503 Loop Isolator Module**
 - **I-M9300 / GST-LD-8300 Addressable Input Module**
 - **I-M9301 / GST-LD-8301 Addressable Output Module**
 - **DI-M9300 Digital Single Input Module**
 - **DI-M9301 Digital Single Input and Output Module**
 - **DI-M9305 Digital Single Riser Output Module**
 - **DI-M9319 Digital Zone Monitor Module**

1.2 Technical Specifications

- ✧ AC Power
 - 120VAC, 60Hz, 2.0A (Maximum Alarm)
Minimum standby current: 0.3A
Maximum standby current: 0.5A
 - 220VAC, 50Hz, 1.0A (Maximum Alarm)
Minimum standby current: 0.15A
Maximum standby current: 0.3A
 - Wire size: minimum 14AWG (2.00mm²) with 600V insulation. The FACP shall be connected to max branch circuit of 15A.

Note:

- (1) Please note the mains input (with ground bonding wire) must be in compliance with ratings on the panel's label.**
- (2) Pin X2 on power supply & loop interface board is for input voltage setup,**

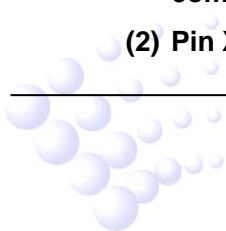

which must comply with the actual supply power. When X2 is shorted, the FACP should work under 120VAC. When X2 is disconnected, the FACP should work under 220VAC.

- ✧ Battery (Sealed Lead Acid Only) - (BAT+, BAT-)
 - Rated voltage: 24VDC, Maximum voltage 27VDC
 - Maximum charging current: 1.10A
 - Float charging voltage: 27.5VDC
 - Type of suitable battery: 24V / 20Ah
 - Derating feature: 15 percent of full capacity.
- ✧ SLC(Signaling Line Circuit) LOOP - XT4, XT6
 - 24VDC nominal, 28VDC maximum
 - Maximum length is 4000ft.
 - Maximum loop current is 0.2A(short circuit) . See also Section 7 for relationship between max. wire length and loop current.
- ✧ NAC (Notification Appliance Circuit) - XT8 (NAC1) & XT7 (NAC2)
 - Power-limited, supervised, and regulated circuit.
 - Maximum voltage drop in wiring: 2.0VDC
 - Nominal operating voltage: 24VDC
 - Current-limit: electronic, power-limited circuit.
 - Rated signaling current per circuit: 0.001A (see Fig. 1-1)
 - Maximum signaling current per circuit: 1.2A (see Fig. 1-1)
 - End-of-line resistor: 4.7 kOhm for Style Y (Class B) NAC
- ✧ Three Fixed Relay: XT13 (Supervisory), XT11 (Alarm) & XT12 (Fault) - For common use.
 - Contact rating: 2.0A @ 30VDC (resistive).
 - Refer to Fig. 2-5 for information on power-limited relay circuit wiring.
- ✧ 24VDC: XT10
 - Power-limited, supervised, and regulated circuit.
 - Maximum voltage drop in wiring: 2.0VDC
 - Nominal operating voltage: 24VDC
 - Current-limit: fuseless, electronic, power-limited circuit.
 - Standby rating current per circuit: 0.05A
 - Maximum signaling current per circuit: 0.75A
- ✧ EIA-485: XT1 (For Future Use)
Auxiliary output: Terminal 1 (A) and Terminal 2 (B) - no connection.
- ✧ Current Availability

The following figure illustrates the maximum current available from the FACP.

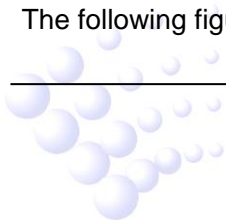

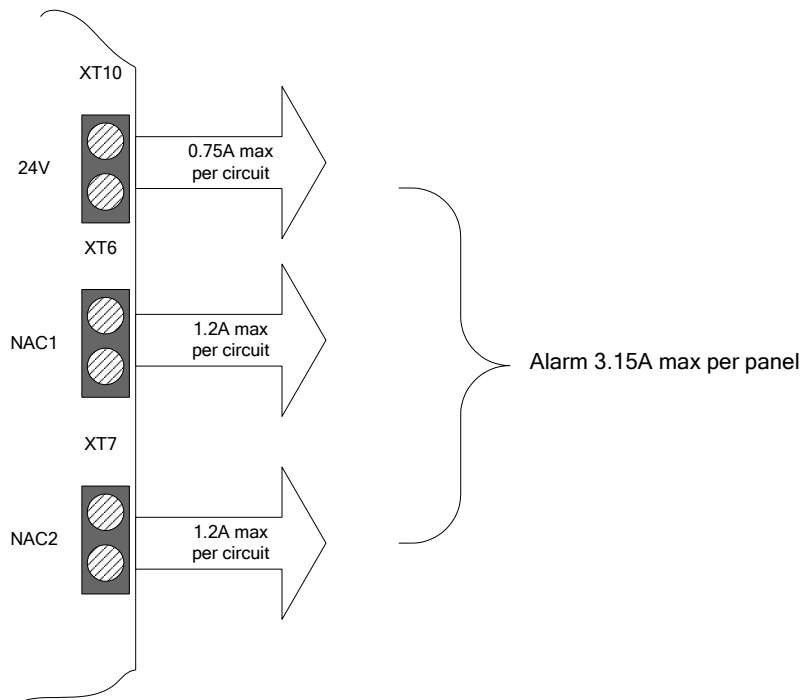

Fig. 1-1

1.3 Controls and Indicators

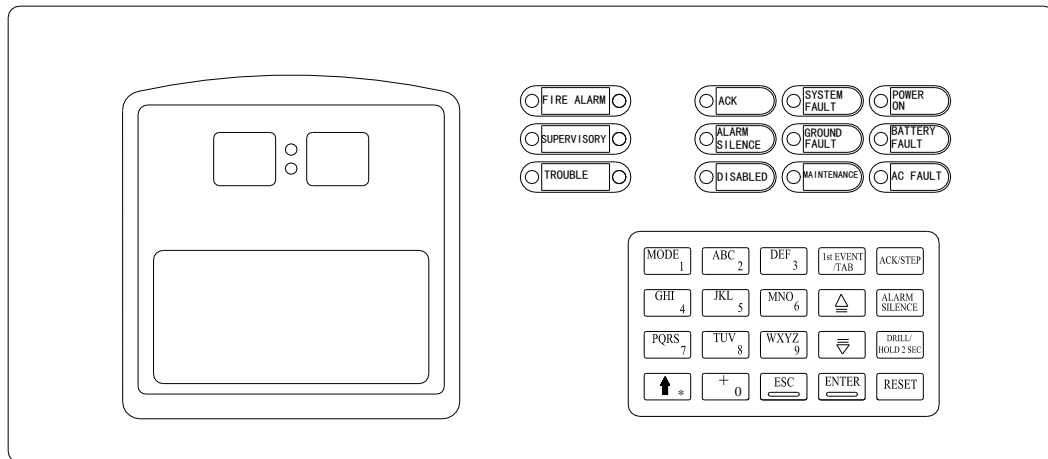

Fig. 1-2

1.3.1 LCD Display

The FACP uses a 128 x 64 LCD for displaying normal monitoring, fire alarm, trouble and supervisory messages.

1.3.2 LED Indicators

- ✧ FIRE ALARM: Twin red LED
- ✧ ACK: Yellow
- ✧ SYSTEM FAULT: Yellow

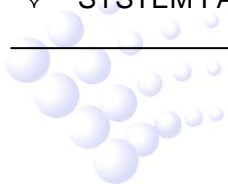

- ✧ POWER ON: Green
- ✧ SUPERVISORY: Twin yellow LED
- ✧ ALARM SILENCE: Yellow
- ✧ GROUND FAULT: Yellow
- ✧ BATTERY FAULT: Yellow
- ✧ TROUBLE: Twin yellow LED
- ✧ DISABLED: Yellow
- ✧ MAINTENANCE: Yellow
- ✧ AC FAULT: Yellow



1.3.3 Control and Indicating Part

Mounted on the main circuit board, the control and indicating part includes an LCD display, the above listed LED indicators and 20 keys.

1.3.4 Functional keys

- ✧ ACK/STEP
- ✧ ALARM SILENCE
- ✧ DRILL/HOLD 2 SEC
- ✧ RESET

1.3.5 Service / Program Keys:

- ✧ Keys labeled with numbers and letters: ABC2, DEF3, GHI4, JKL5, MNO6, PQRS7, TUV8, WXYZ9
- ✧ 
- ✧ + 0
- ✧ 1st EVENT/TAB
- ✧ ESC
- ✧ MODE 1
- ✧  , 
- ✧ ENTER

1.4 Circuits

- ✧ SLC (Signaling Line Circuit) Loop

One SLC loop is provided standard on the FACP loop interface board. The SLC loop, configurable for Style 6 (Class A), provides communication to addressable detectors, monitor and control modules. In case of short circuit or open circuit of the loop, detectors protected by loop isolators will not be lost. The FACP reports loop fault.

- ✧ NAC (Notification Appliance Circuit) — Two Style Y (Class B) NACs

NAC1 (+, -): It outputs when there is fire alarm, which can be stopped by pressing

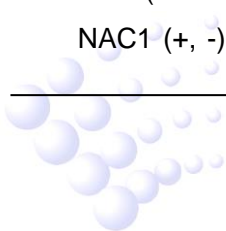

ALARM SILENCE key. Output can be silenced. The FACP will report fault when connected cable is in short or open circuit or ground fault.

NAC2 (+, -): It outputs when there is fire alarm, which can be stopped by pressing *ALARM SILENCE* key. Output can be silenced. The FACP will report fault when connected cable is in short or open circuit or ground fault.

✧ Relays (For Common Use)

Three relay outputs are provided, controlling the fault, fire and supervisory state. Contact capacity is 2.0A @ 30VDC (resistive).

- ALARM (COM, NC, NO): The normally open contact closes if fire alarm condition occurs and can be disconnected if the alarm is cleared.
- FAULT (COM, NC, NO): The normally open contact closes if fault condition occurs and can be disconnected if the fault resets.
- Supervisory (COM, NC, NO): The normally open contact closes if abnormal condition occurs and can be disconnected if the abnormal condition resets.

✧ Auxiliary Power Output

24V, GND: Auxiliary 24VDC output.

✧ EIA-485 Output: RS485 communication interface for networking. No connection, for future use.

1.5 Components

A standard FACP consists of one of each of the following: main board, loop power interface board.

- ✧ Main Board: Main board is the core of the FACP, containing the system's CPU and wiring interface with other main and optional components.
- ✧ Loop Power Interface Board: Providing power for the main board and managing battery charging. This is also the signal interface board for communication, detection, fire alarm output and fault output, for the FACP to complete a fire alarm system with all periphery devices.

1.6 Peripheral Devices

1.6.1 Series Addressable Detectors

Intelligent, addressable detectors provide information to the FACP on an SLC (Signaling Line Circuit). This allows the FACP to continually monitor the status (alarm, trouble, maintenance or normal) of each detector.

✧ Smoke Detectors (Photoelectric)

I-9102(UL) / JTY-GD-G3 Intelligent Photoelectric Smoke Detector is developed on the principle of infrared scattering. With integrated microprocessor and amplifier, the detector has the following features:

- Addressable code written by a programmer makes the detector easy and reliable

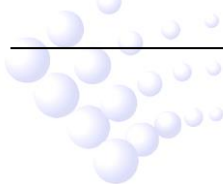

to commission.

- The microprocessor disposes data by sampling and can save 14 history records. The curve displayed on the FACP shows the field conditions.
- Compensating excursion of temperature and humidity, detecting dust accumulation fault.

✧ Heat Detectors

I-9103(UL) / JTW-ZCD-G3N Intelligent Rate of Rise and Fixed Temperature Heat Detector uses a thermistor as its sensor. The built-in microprocessor processes the signal from the sensor by intelligent algorithm. The detector has the following features:

- Addressable code is written by programmer.
- The microprocessor disposes data by real-time sampling and can store 14 history records. The curve displayed on the FACP shows the field condition.
- The detector can be set by programmer to be rate-of-rise detector or fixed temperature detector.

✧ Detector Bases

DZ-03 Base is used to mount conventional and intelligent smoke, heat and combination detectors as their conductive base. During installation, you can easily fix the base before connecting cables, and then twist the detector onto the base.

1.6.2 Manual Pull Stations

UL listed conventional manual pull stations can be connected through GST-LD-8300 / I-M9300 Module to complete a fire alarm system.

1.6.3 Loop Isolators

In loop type fire alarm system, short circuit of part of the loop often affects normal operation of the whole system. GST-LD-8322 / C-9503 / C-M9503 Loop Isolator can disable the shorted part of loop from the whole system to ensure normal operation of other parts and can easily find the location of the disabled part.

1.6.4 Control Modules

- ✧ I-M9300 / GST-LD-8300 Addressable Input Module is used to receive normally open switch signals from connected fire protection devices, and transmit the messages back to the FACP.
- ✧ I-M9301 / GST-LD-8301 Addressable Output Module works in two-wire mode. On receiving start command from the FACP, it will close the output relay to output normally-open / normally closed contact signal and illuminate the Active indicator.

1.6.5 Synchronization Module and Horn / Strobes Module

- ✧ Synchronization Module: UL listed I56-0983-015R MDL Module manufactured by System Sensor;
- ✧ Horns/Strobes: UL listed P2475RLP, P2475RLPW manufactured by System Sensor.

NOTE: If the FACP is to be connected with a synchronization module, the cables between them are to be protected with metal conduits.

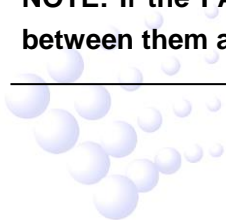

1.7 Accessories

- ✧ GST Series Hand Held Programmer

P-9910B / GST-BMQ-1B Hand Held Programmer can read the address, sensitivity and device type and program device type of addressable detectors, modules and repeater panels.

The handheld programmer has to be separately ordered.

1.8 Getting Started

The following is a summary of the basic steps to bring a GST-M200 FACP on-line:

- ✧ Install the cabinet (refer to *Section 2.1 Installing the Cabinet*)
- ✧ Connect with addressable devices
- ✧ Enter Auto-programming (refer to *Section 3.5*)
- ✧ Define devices (refer to *Section 3.4.3*) and Event and Command (E&C) equation (refer to *Section 3.4.5*)

2 Installation

The cabinet mounts using three 12mm-diameter holes located in the back box.

Carefully unpack the system and check for shipping damage. Mount the cabinet in a clean, dry, vibration-free area where extreme temperatures are not encountered. The area should be readily accessible with sufficient room to easily install and maintain the panel. Locate the cabinet at a proper height above the floor with the hinge mounting on the right.

2.1 Installing the Cabinet

The FACP can be flush-mounted or wall-mounted. The dimensions for wall-mounting are shown in Fig. 2-1.

- ✧ Mark and predrill holes in the wall for the three keyhole mounting bolts using the dimensions illustrated in Fig. 2-1.
- ✧ Install three fasteners in the wall with the screw heads protruding.
- ✧ Using upper 'keyhole' place back box over the three screws, level and secure.

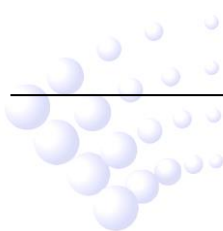

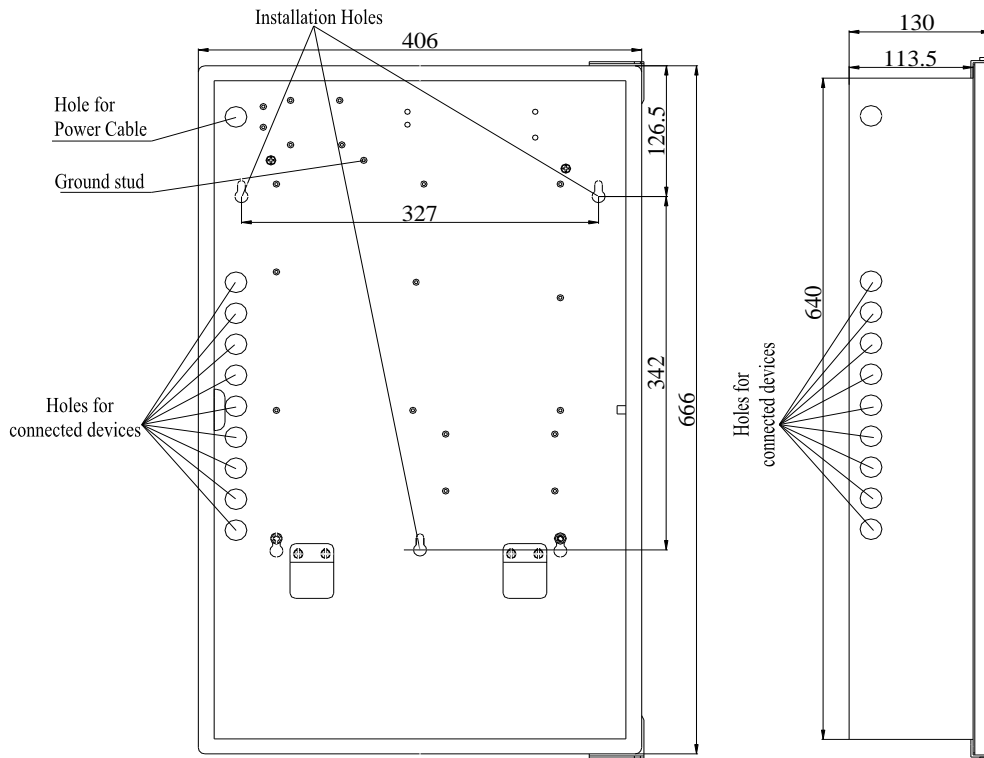
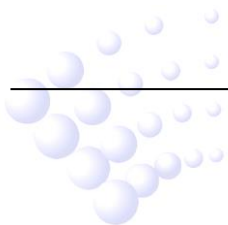

Fig. 2-1

Dimensions for flush-mounting are shown in Fig. 2-2.

Hole distance for flush-mounting: 640mm x 380mm x 113.5mm



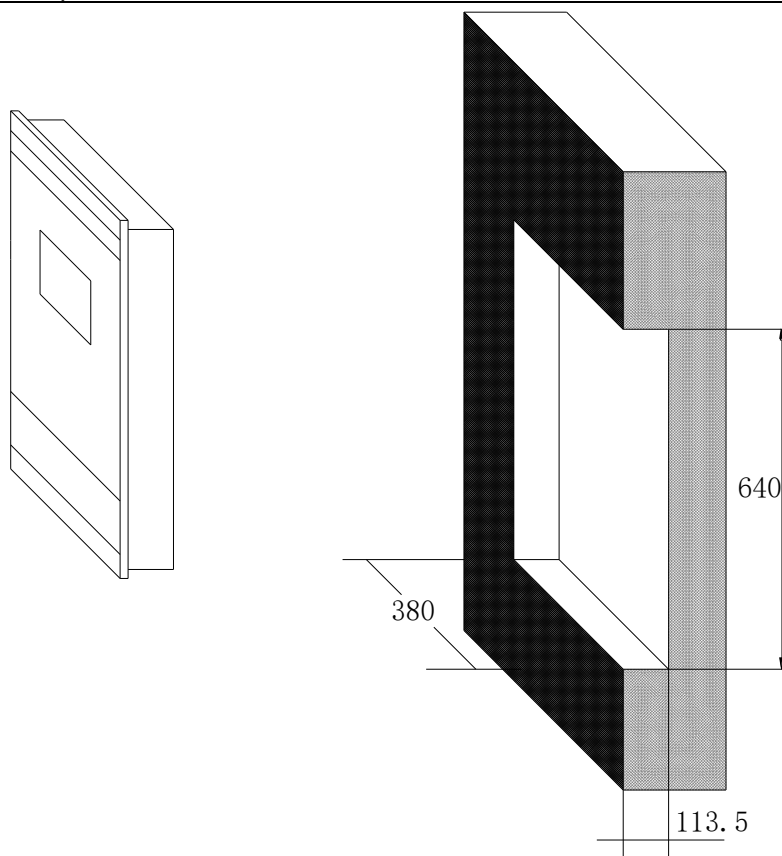

Fig. 2-2

2.2 Power



WARNING: Several different sources of power can be connected to this panel. Disconnect all sources of power before servicing. The panel and associated equipment may be damaged by removing and/or inserting cards, modules or interconnecting cables while this unit is energized.

2.2.1 AC Power and Earth Ground Connection

Primary power required for the FACP is 120VAC, 60 Hz, 2.4A or 220VAC, 50 Hz, 1.2A for the FACP. Over-current protection for this circuit must comply with Article 760 of the National Electrical Code (NEC) and/or local codes. Use 14AWG (2.00mm²) or larger wire with 600 volt insulation rating. Make certain that the AC mains circuit breaker is off before wiring any connections between the mains and the control panel. Connect power supply to the Terminal XT1, as shown in Fig. 2-3. **Note: Verify all cables are correctly connected before connecting power supply.**

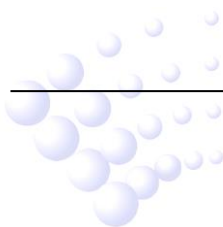

Note: Please make sure the mains power is in line with the rated voltage marked on the panel's label.

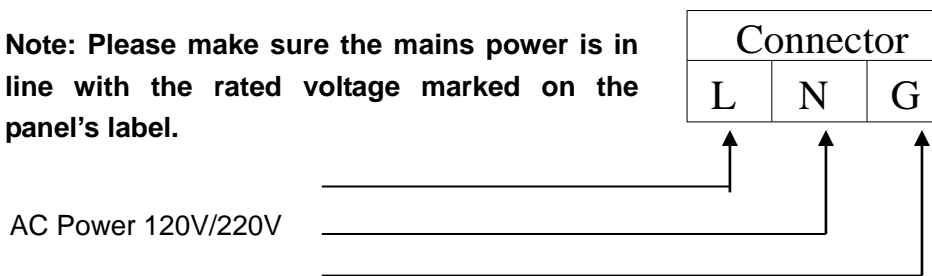

Fig. 2-3

Connect a wire from the grounding stud in the cabinet to a known solid earth ground in the building. Refer to Fig. 2-1 for location of the stud. This connection is vital for maintaining the control panel's immunity to unwanted transients generated by lightning and electrostatic discharge. Apply AC power to the panel only after the system is completely installed and visually checked.

2.2.2 Battery Power

Before connecting the batteries to the FACP, make certain that the interconnect cable between the batteries is not connected. Do not connect the interconnect cable until the system is completely installed. Observe polarity when connecting the batteries.



WARNING: Battery contains sulfuric acid, which can cause severe burns to the skin and eyes and can destroy fabrics. If contact is made with sulfuric acid, immediately flush the skin or eyes with water for 15 minutes and seek immediate medical attention.

2.3 24VDC Power Output Connection

24VDC power output is Power-limited, supervised and regulated.

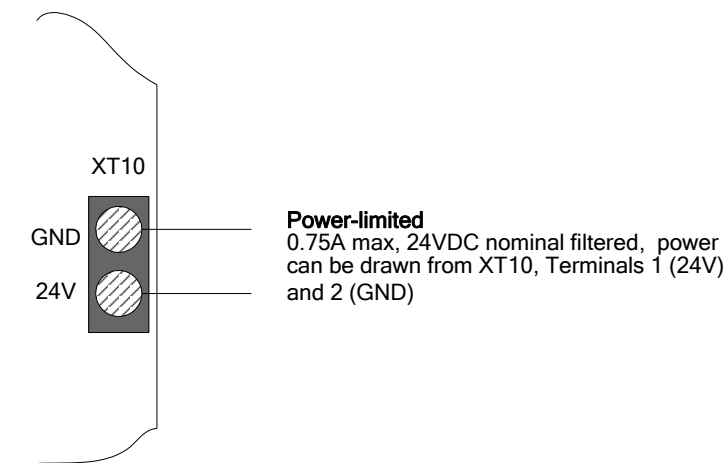
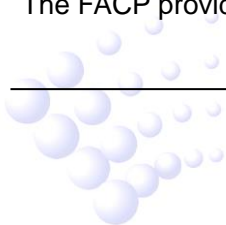
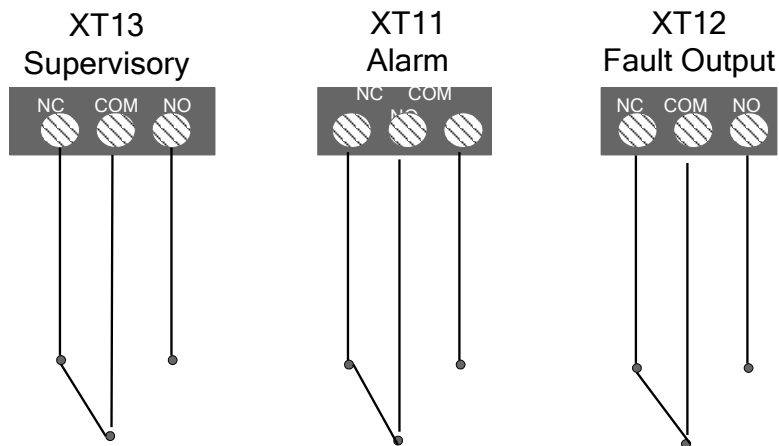

Fig. 2-4

2.4 Relays (For Common Use)

The FACP provides three relays, with contacts rated 2.0A @ 30VDC (resistive).





Relay contacts shown with power applied to panel and no active fault, alarm or supervisory.

Fig. 2-5

2.5 Notification Appliance Circuits (NAC)

There are two Style Y (Class B) NAC outputs on the loop interface board. Each circuit is capable of 1.2A of current. Total current in alarm for all external devices cannot exceed 2.4A. Use System Sensor's UL listed sounders (see Section 1.6.5) that can work at regulated 24VDC. Circuits are regulated, supervised and power-limited.

2 Style Y (Class B) Notification Appliance Circuits,
 regulated, supervised and power-limited - 4.7 kOhm EOL

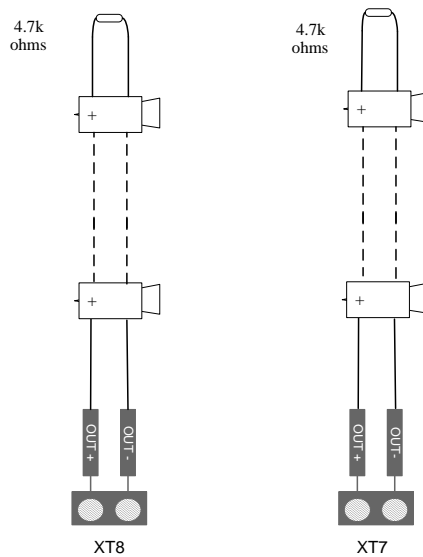
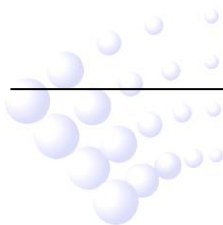

Fig. 2-6



2.6 Signaling Line Circuits (SLC)

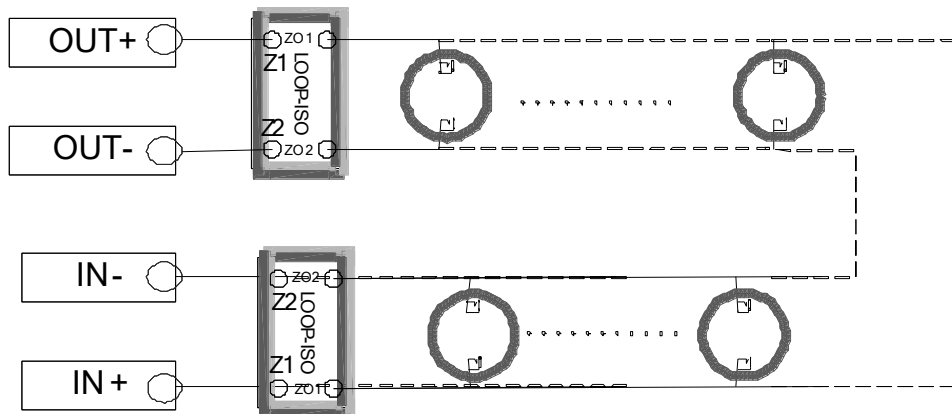

Fig. 2-7

Connection of SLC:

C-9503 / C-M9503 / GST-LD-8322 Loop Isolator must be connected in SLC loop, each administrating a maximum of 30 addressable devices. The SLC can have at most 240 devices. Compatible devices are I-9102(UL) / JTY-GD-G3 Intelligent Photoelectric Smoke Detector, I-9103(UL) / JTW-ZCD-G3N Intelligent Rate of Rise and Fixed Temperature Heat Detector, I-M9300 / GST-LD-8300 Addressable Input Module, and I-M9301 / GST-LD-8301 Addressable Output Module.

2.7 UL Power-limited Wiring Requirements

Power-limited and nonpower-limited circuit wiring must remain separated in the cabinet. All power-limited circuit wiring must remain at least 0.25" (6.35mm) away from any nonpower-limited circuit wiring and nonpower-limited circuit wiring must enter and exit the cabinet through different knockouts and/or conduits. A typical wiring diagram for the GST-M200 is shown below.

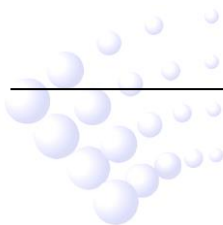

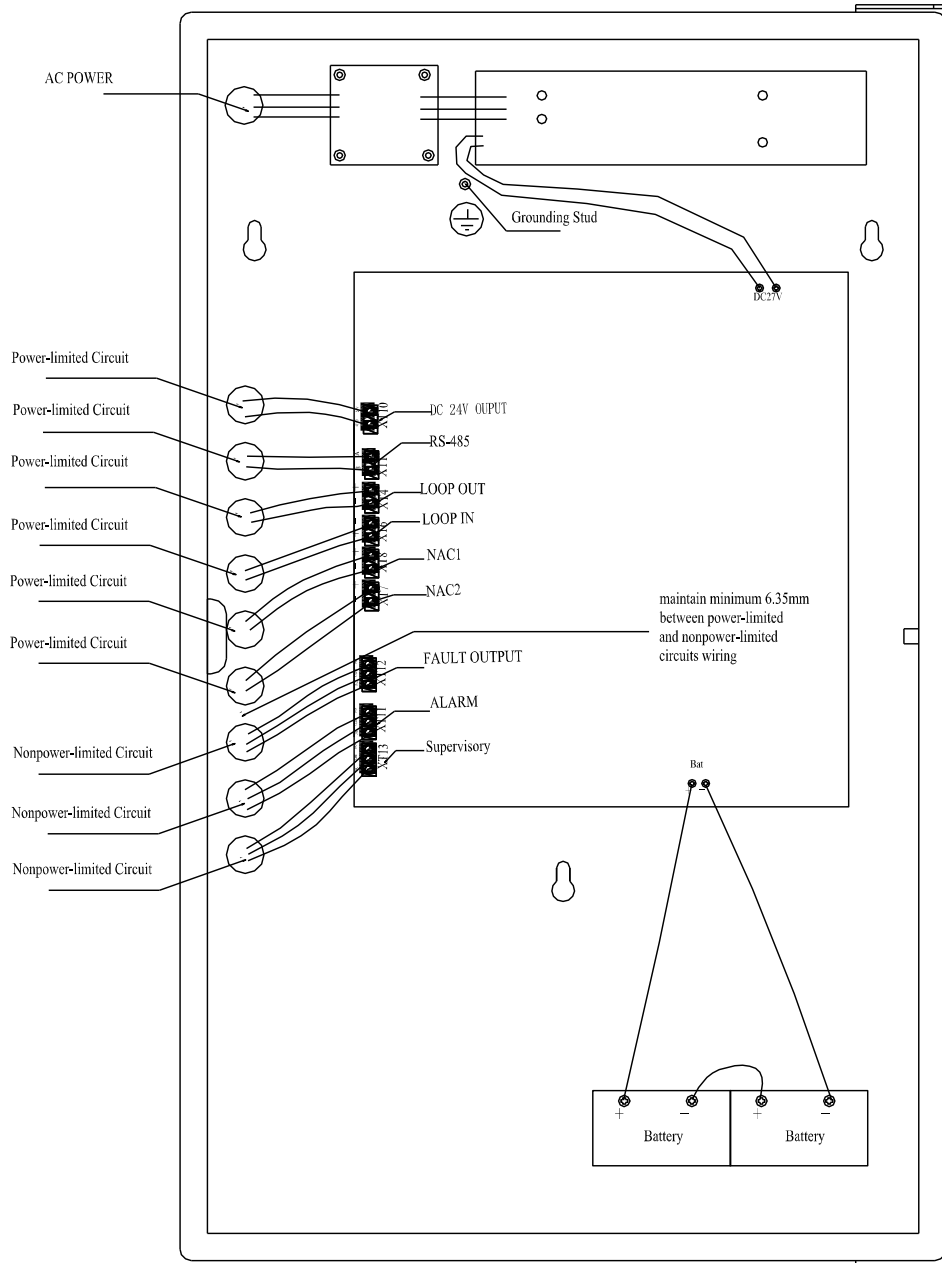

Fig. 2-8









3 Programming

3.1 Programming Data Entry

Totally 16 keys are provided: **MODE 1**; **ABC 2**; **DEF 3**; **GHI 4**; **JKL 5**; **MNO 6**; **PQRS 7**;
TUV 8; **WXYZ 9**; **↑ ***; **+ 0**; **1st EVENT/TAB**; **ESC**; **△**; **▽**; **ENTER**.

- ✧ Press *MODE* to enter operation menu;
- ✧ Under operation menu, pressing number keys can lead the FACP to sub-menus or corresponding functional status. Pressing *ESC* or *ENTER* can exit the present level.

- ✧ In input mode, the cursor indicates the position. To input numbers, press the number keys directly. If “*” is to be used, press the “*” key. If more than one data section exists, the cursor goes to the next section after the present section is finished.

Press TAB to go to the next, or ,  to the previous. Within a section, press 
or  to change the input position.
- ✧ For text input, pressing  to change among input modes for capital letter (T) and lower case (t), number input (1) and text (w).
- ✧ Input of capitalized and lower case characters: Taking  as an example. Pressing this key once, “A” is input. Pressing twice for “B” and three times for “C”. Pressing four times, it’s “A” again. If a letter is input, and no key is pressed in 2 seconds, the cursor will move to the next position. Symbols can be selected by pressing “+” among the following options: “blank”; “-”; “(“; “)”; “!”; “.”; “,”; “.”; “+”, “-”; “&”; “=”; “*”; “@”; “#”; “\$”; “%”; “[“, “]”.
- ✧ Number input: Press the numbers on the keys.
- ✧ User-defined text input: When the screen indicates “w”, press any number key to enter phrase selection screen. Selecting the number of the phrase and pressing *ENTER* can insert this phrase to the cursor position.
- ✧ Modifying input message: Pressing  and  to move the cursor for modification.

3.2 Description of Programming Screens

If *MODE* is pressed, six options will be available on the screen as shown in Fig. 3-1: Read Status, Programming, Autoprogram, Disable/Enable, Walk Test, and Configure Item. In which *Read Status* and *Programming* have multiple levels of submenu that can be accessed by pressing number keys, or exited at any time by pressing *ESC* repeatedly.

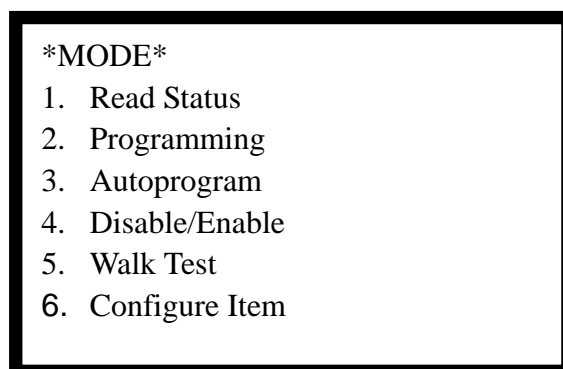
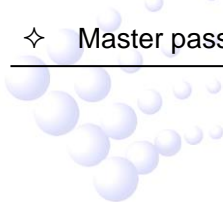

Fig. 3-1

3.3 Programming and Passwords

There are two user-programming levels:

- ✧ Master password is used for programming panel specific data relating to device types,



messages, control panel functions, etc.

- ✧ Maintenance password is used by a qualified operator to access features such as Autoprogram, Disable/Enable, Walk test and Configure Item.

3.4 Programming (Master)

Select “2. Programming” in the screen shown in Fig. 3-1, the system will request for password. If master password is entered, the LCD will display the messages shown in Fig. 3-2.

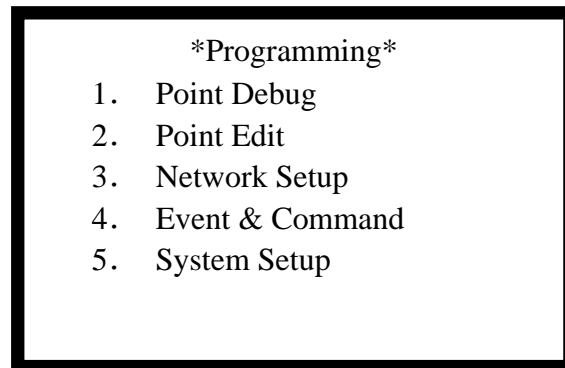

Fig. 3-2

- ✧ Selecting “1. Point Debug” by entering “1” to view supervisory value of addressable devices.
- ✧ Selecting “2. Point Edit” by entering “2” to define SLC addressable devices.
- ✧ Selecting “3. Network Setup” by entering “3” to set the FACP into network.
- ✧ Selecting “4. Event & Command” by entering “4” to edit E&C equation.
- ✧ Selecting “5. System Setup” by entering “5” for system setting.

3.4.1 System Setup

Select “5. System Setup” in the screen of Fig. 3-2 to enter the screen shown in Fig. 3-3.

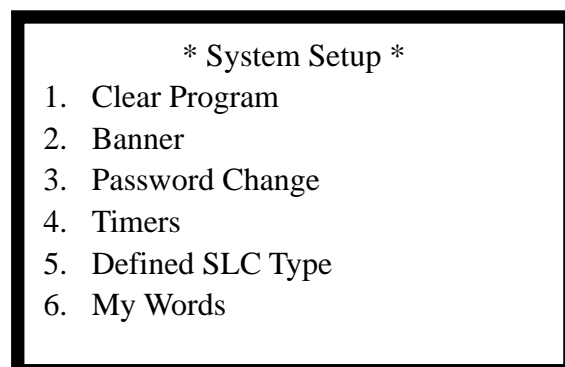
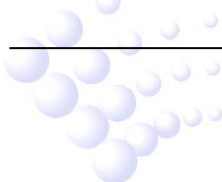

Fig. 3-3

- ✧ Selecting “1. Clear Program” by entering “1” to clear the memory and restore factory default.
- ✧ Selecting “2. Banner” by entering “2” to edit the banner contents.



- ✧ Selecting “3. Password Change” by entering “3” to set system password.
- ✧ Selecting “4. Timers” by entering “4” to set delay time of PAS.
- ✧ Selecting “5. Defined SLC Type” by entering “5” to define device type of the SLC devices.
- ✧ Selecting “6. My Words” by entering “6” to define text messages.

3.4.1.1 Clear Program

Select “1. Clear Program” in the screen shown in Fig. 3-3. By entering a fixed password 19491001, the system can be restored to factory default, as in Fig. 3-4.

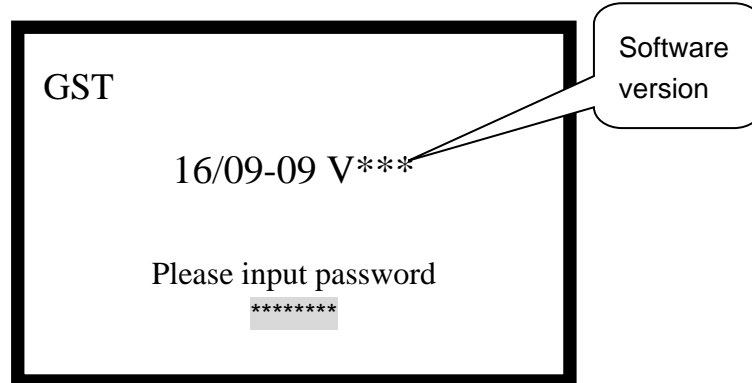

Fig. 3-4

Note:

In the above example, “GST” is the contents of the banner.

3.4.1.2 Banner

The contents of the banner are user-definable by selecting “2. Banner” in the screen of Fig. 3-3, the LCD will display the screen in Fig. 3-5.

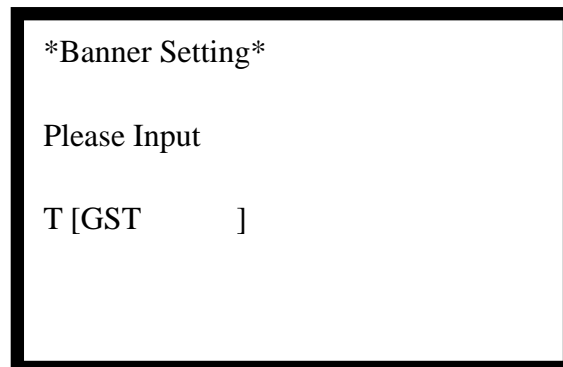
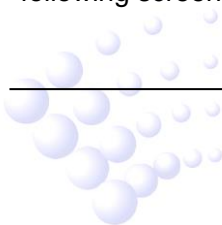

Fig. 3-5

At most 18 characters can be entered for the text of the banner. Please refer to Section 3.1 for detailed instructions.

3.4.1.3 Password Change

Selecting “3. Password Change” in the screen of Fig. 3-3 can set system password. The following screen will appear:



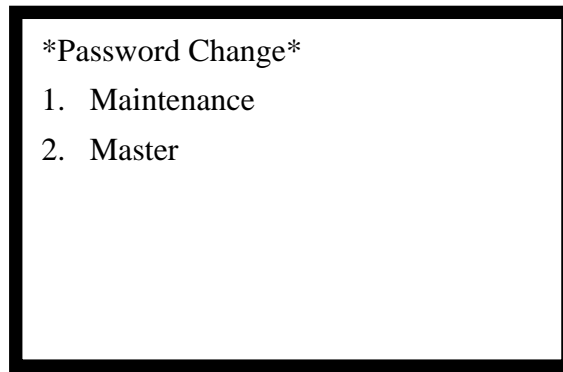

Fig. 3-6

1. Modifying Maintenance Password

Selecting "1. Maintenance" in the screen shown in Fig. 3-6 will cause the screen in Fig. 3-7 to appear for modifying maintenance password.

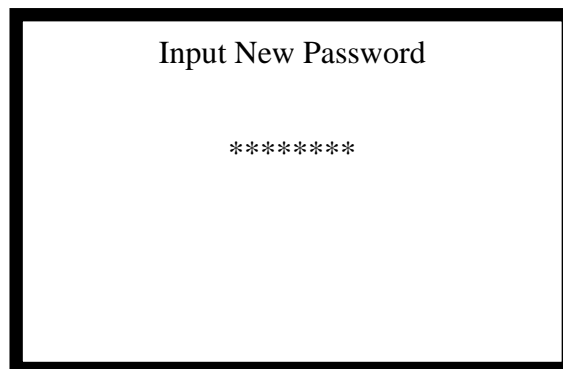

Fig. 3-7

2. Modifying Master Password

Selecting "2. Master" in the screen shown in Fig. 3-6 can modify Master password. The method is the same as modifying Maintenance password.

3.4.1.4 Timers

Selecting "4. Timers" in the screen shown in Fig. 3-3 can set the delay time of PAS. The following screen appears:

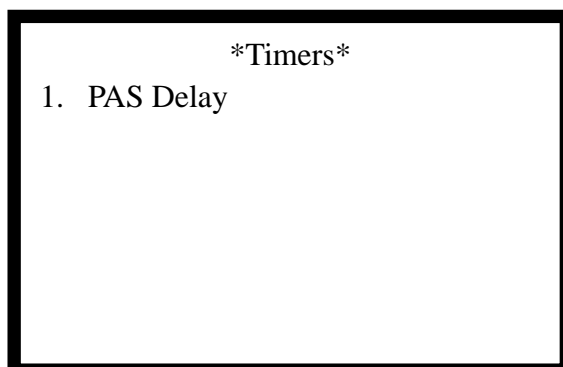
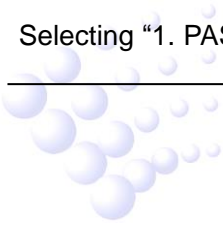

Fig. 3-8

Selecting "1. PAS Delay" in the screen shown in Fig. 3-8, the following screen will appear



for setting PAS delay time.

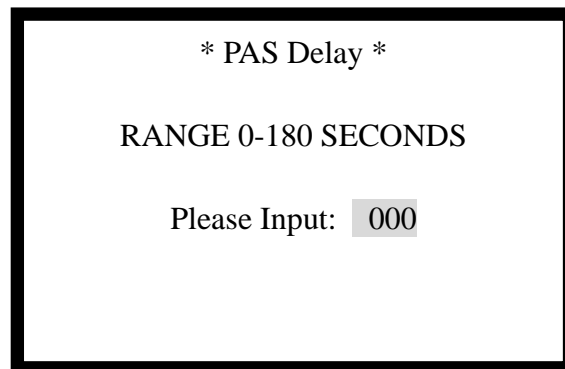

Fig. 3-9

System default delay time is 000, which can be set from 0~180 seconds.

3.4.1.5 User Defined SLC Type

This FACP supports 15 user-defined device types, which are from @\x0~@\xe in Table 3-1. With this option, the user can define those devices not included in the device type list. Before defining devices for a specific project, the user needs to check whether all devices for the project are in the device type list. If not, the device types not included should be defined before starting device definition.

Selecting “5. Defined SLC Type” in the screen of Fig. 3-3 will cause the following screen to appear for user-definable SLC devices.

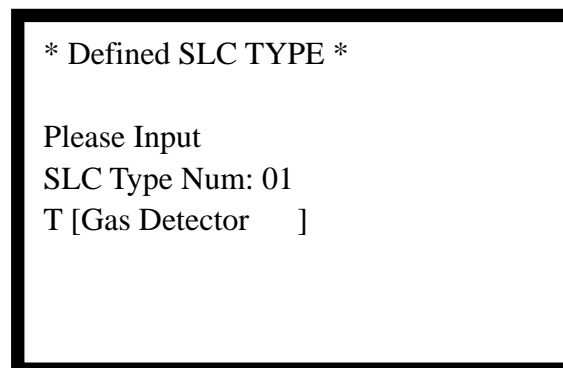
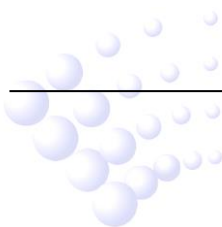

Fig. 3-10

To define an SLC device, the number of the user-defined device should be input, and then its device type (Maximum 14 characters), like the “Gas Detector” in the above example. Please refer to Section 3.1 for how to edit the texts.

3.4.1.6 My Words

Selecting “6. My Words” in the screen shown in Fig. 3-3, the following screen will appear:



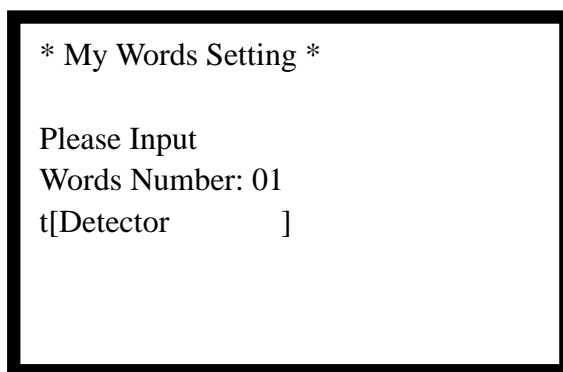

Fig. 3-11

Here the user can define some commonly used phrases, which can then be used later when defining devices or entering other text to save programming time. To do this, the user needs to input the number of the text first, then the text itself (12 characters at most), like “Detector” in the above example. Please refer to Section 3.1 for how to edit the text. Please note that there is no text available yet when defining the first text.

3.4.2 Point Debug

Selecting “1. Point Debug” in the screen in Fig. 3-2, the screen for viewing supervisory value of addressable devices will be displayed, as in Fig. 3-12:

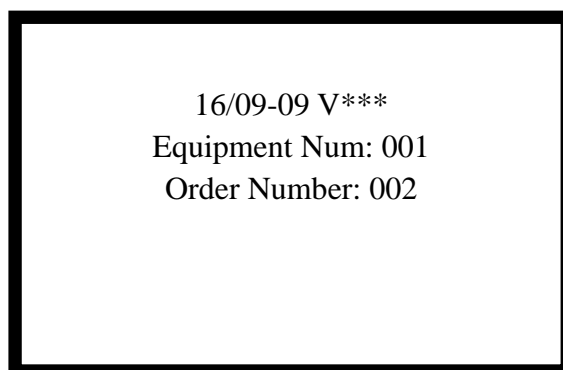

Fig. 3-12

Entering the equipment number and the order number can view the supervisory value of addressable devices.

Pressing different number keys represent different commands:

- ✧ Key “0” represents the command “Polling”. If the displayed value is between 450~650, the device is in normal operation; if it’s between 900~1200, the device is in alarm status, and if it’s between 0~120, the device is in fault.
- ✧ “1” represents “registration” command, and 720 for normal.
- ✧ “2” represents the command “viewing dynamic data” for reading real time data of detectors.
- ✧ “15” means “Start” command, which can start the output of corresponding modules, or light the alarm LED of addressable devices.

Other numbers are reserved for future expansion.

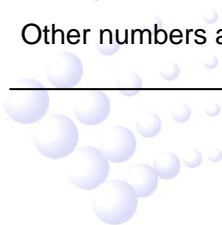

3.4.3 Point Edit

3.4.3.1 Function

The “Point Edit” option allows the operator to define the address, type, location, zone number of a device. With these information defined, the operator can quickly find the alarm zone and take timely measures in case of fire or trouble.

3.4.3.2 Basic Steps for Device Definition

Selecting “2. Point Edit” in the screen in Fig. 3-2, the LCD will display the following:

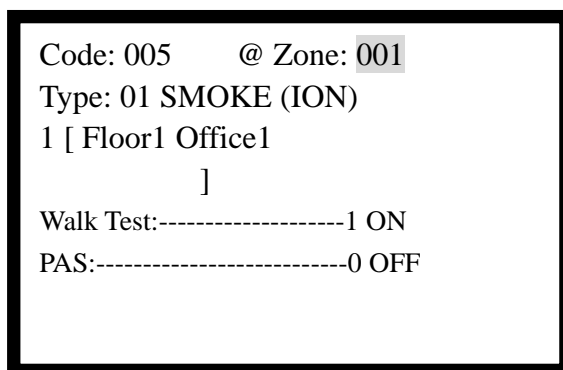

Fig. 3-13

1. Defining detectors

- ✧ First input detector code, then press *Enter*, the display will indicate to input zone information.
- ✧ Input the zone number.
- ✧ Press *TAB* to move the cursor to device type area and select the type (such as SMOKE (ION) as shown in Table 3-1). Note: If a detector is selected to be a SUPERV DUCTP type, it will function like a supervisory point when it senses smoke. The Supervisory LED and supervisory relay will be activated.
- ✧ Press *TAB* to move to device description area, and input the text for describing the device (32 characters at most). Please refer to Section 3.1 for how to edit the text.
- ✧ Press *ENTER*, the state of Walk Test and PAS for this device will appear at the lower part of the screen, of which “0” means OFF and “1” means ON.

➤ Walk Test

The walk test feature allows one person to test the system without manually resetting the control panel after activation of a device. To enable a device for the walk test feature, input number “1”, the display is “ON”; To disable the walk test feature, input number “0”, the display changes to “OFF”.

➤ Positive Alarm Sequence (PAS)

The Positive Alarm Sequence (PAS) option will program the detector to delay panel activation (including alarm relay) for a period of 15 seconds plus a programmable time of up to 3 minutes. To enable a device for the PAS feature, input number “1”, the display changes to “ON”; To disable the PAS feature, input number “0”, the display changes to “OFF”. Please refer to Section 4.9 for detailed operation procedure of

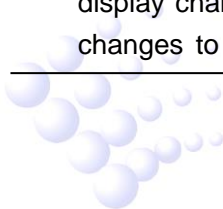

PAS.

2. Defining modules

- ✧ First enter the device code, press *ENTER*, the LCD indicates to input zone number.
- ✧ Input the zone number of the device.
- ✧ Pressing *TAB* to move the cursor to device type setting area for selecting device type (for example, SMOKE (ION), refer to Table 3-1).

Selection of device type of detectors and monitor modules will affect the function of the point as in Table 3-1:

Table 3-1

Device Type	No.	Action When Activated
Undefined	00	Undefined
SMOKE(ION)	01	Fire Alarm
SMOKE(PHOTO)	02	Fire Alarm
SMOKE-DUCT-P	03	Fire Alarm
HEAT DETECT	04	Fire Alarm
BEAM DETECT	05	Fire Alarm
PULL STATION	06	Fire Alarm
@\x0	07	Fire Alarm
@\x1	08	Fire Alarm
@\x2	09	Fire Alarm
@\x3	10	Fire Alarm
Waterflow	11	Fire Alarm
@\x4	12	Supervisory, latching
@\x5	13	Supervisory, latching
@\x6	14	Supervisory, latching
@\x7	15	Supervisory, latching
Supervisory	16	Supervisory, latching
Supervisory-AR	17	Supervisory, non latching (tracking)
@\x8	18	Supervisory, non latching (tracking)
Bell Circuit	19	Control Type
Horn Circuit	20	Control Type
Sounders	21	Control Type
Relay	22	Control Type
Strobe Circuit	23	Control Type
Control	24	Control Type
@\x9	25	Control Type

@\xa	26	Control Type
@\xb	27	Control Type
@\xc	28	Control Type
NAC	29	Notification Appliance Circuit, can startup, Monitor Trouble
PAS-Bypass	30	PAS Disable
@\xd	31	PAS Disable
FIRE-Relay	32	FIRE ALARM output Relay
Trouble Relay	33	Trouble output Relay
SUPERV Relay	34	Supervisory output
PAS Relay	35	Positive Alarm Sequence ON Relay
TroubleMonitor	36	Trouble
@\xe	37	Trouble
SLC	38	Loop short/open circuit Trouble
GROUND FAULT	39	Ground trouble
BATTERY CHANGE	40	Battery charge trouble
AUX 24V FAULT	41	Auxiliary 24V trouble

- ✧ Pressing *TAB* can move the cursor to device description area to input description text (maximum 32 characters). Please refer to Section 3.1 for how to edit the texts.
- ✧ Pressing *ENTER*, the system will prompt to set properties of walk test and PAS for device type 1~11, walk test and Silenceable features for devices except NACs, and walk test, Silenceable, autosilence and coding for NACs.

➤ **Walk Test**

The walk test feature allows one person to test the system devices without manually resetting the control panel after activation of each device. To enable the walk test feature, input number “1”, the display is “ON”; To disable the walk test feature, input number “0”, the display changes to “OFF”.

➤ **PAS**

To enable the PAS feature, input number “1”, the display is “ON”. To disable the PAS feature, input number “0”, the display changes to “OFF”.

➤ **Silenceable**

Pressing *ALARM SILENCE* key can silence all silenceable devices.

➤ **Auto Silence**

When the Auto Silence feature is enabled, all silenceable notification appliances will be automatically silenced after a programmed period.

3.4.4 Event & Command

Selecting “4. Event & Command” in the screen shown in Fig. 3-2, the control panel enters E&C editing screen, as shown in Fig. 3-14.



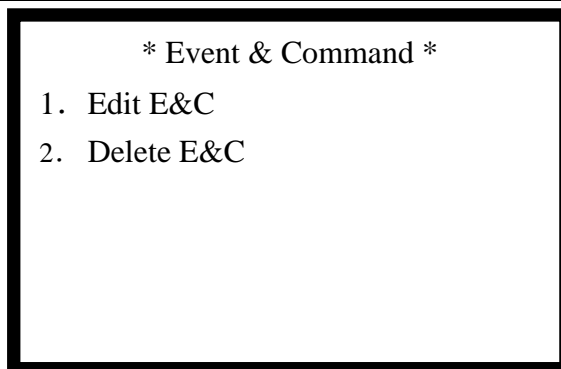

Fig. 3-14

3.4.4.1 Meaning and Use of E&C Equation

1. Use of E&C Equation

An E&C consists of conditions, relation character and results. By setting the E&C equation, the FACP can be programmed to activate some equipment on an alarm.

Note: Definition of E&C has to be done after device definition.

2. Structure and Meaning of E&C

A condition item can consist of several trigger conditions, the relationship among the trigger conditions is “or”. Each individual trigger condition consists of several triggering devices. Only when all these triggering devices alarm, will the trigger condition be satisfied.

Below is an example:

00100101&00100201+00100101&00100301+00100201&00100301+
00100101&00100201&00100301=00100441

In this E&C equation:

- The part before the “=” sign is the condition
- The part after the “=” sign is the result
- “&” means “and”
- “+” means “or”
- 001 001 01

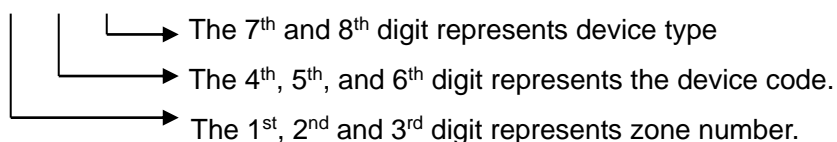

Meaning of this E&C equation: Any two of the three detectors (001, 002 and 003) in Zone 1 alarm, Sounder 4 of Zone 1 will be activated.

3. Meaning of asterisks “*” in E&C equation and how to set up an E&C.

Example: 00100*01&00101*01+00103*01&00104*01=00100441

◇ “*” represents any number between 0~9, which can be entered by pressing the  key;

◇ Input of “&” mark: The software will automatically add a “&” mark after 8 digits

(including “*”) are entered. Changing of an existing “+” to “&” can be done by pressing $\boxed{+ \ 0}$ and inputting “&”.

- ✧ Input of “+”: Press $\boxed{+ \ 0}$ and input “+”.
- ✧ Input of “=”: Press $\boxed{+ \ 0}$ and input “=”.
- ✧ To modify an E&C equation, move the cursor to the modifying position by pressing $\boxed{\triangle}$ and $\boxed{\nabla}$.

Note: “&”, “+”, and “=” can only be activated after 8 digits (including “*”) have been input.

3.4.4.2 Edit E&C

Selecting “1. Edit E&C” in the screen shown in Fig. 3-14, the FACP enters the screen of editing E&C, as shown in Fig. 3-15.

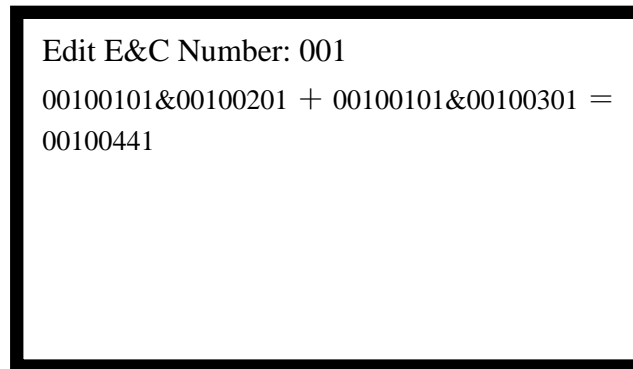

Fig. 3-15

3.4.4.3 Delete E&C

Selecting “2. Delete E&C” in the screen shown in Fig. 3-14, the FACP enters the screen of deleting existing E&C, as in Fig. 3-16.

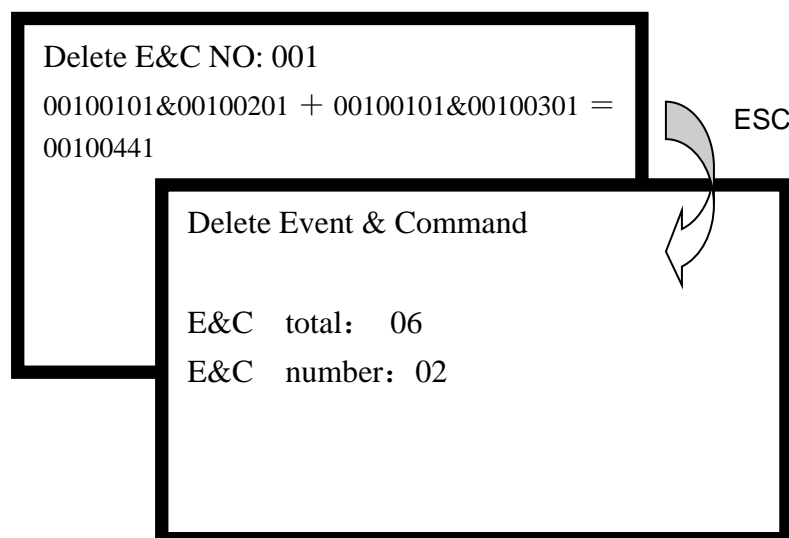

Fig. 3-16

Pressing *ENTER* can delete the E&C equation. Pressing *ESC*, the E&C will not be deleted, and you can select the number of other E&C to delete.



3.5 Autoprogram (Master Password)

Select “3. Autoprogram” in the screen shown in Fig. 3-1, which is password protected. After entering master password, the system will register devices connected and networked, as in Fig. 3-17.

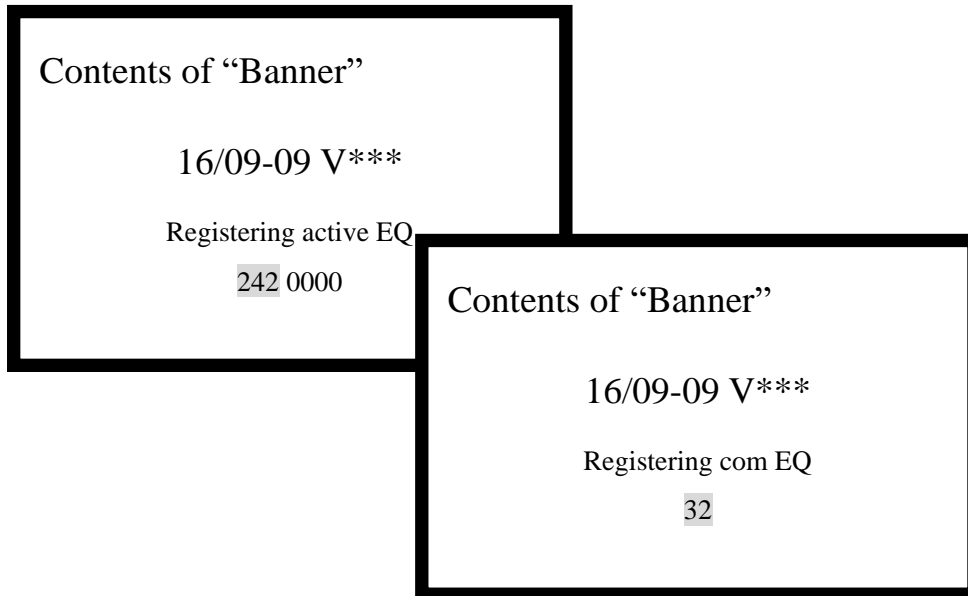

Fig. 3-17

3.6 Disable / Enable (Maintenance Password)

Select “4. Disable/Enable” in the screen shown in Fig. 3-1, which is also password protected. After entering maintenance password, addressable devices can be enabled or disabled, as in Fig. 3-18.

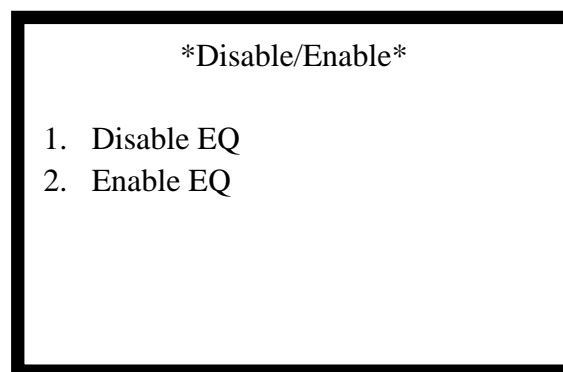
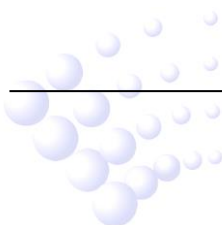

Fig. 3-18

✧ Selecting “1. Disable EQ”, devices can be disabled, as shown in Fig. 3-19.



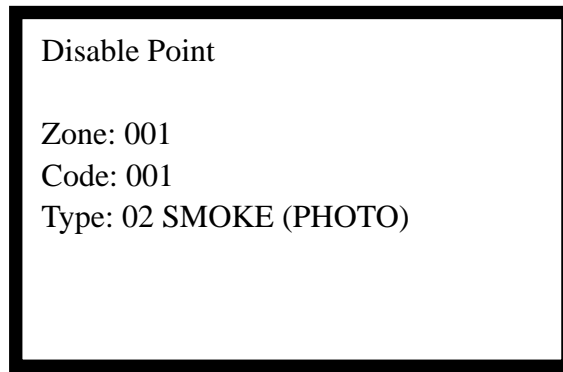

Fig. 3-19

Entering its zone number, code and type in sequence can disable a device.

✧ Selecting “2. Enable EQ”, disabled devices can be enabled, as in Fig. 3-20.

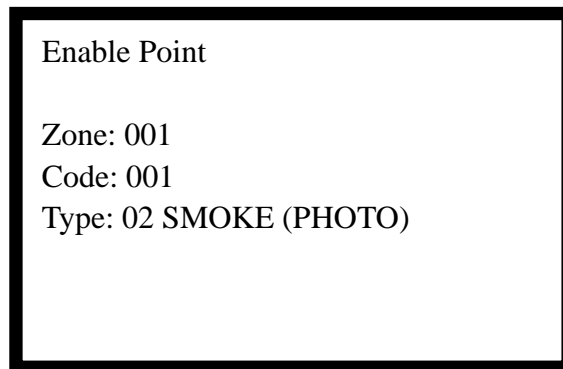

Fig. 3-20

Entering its zone number, code and type in sequence can enable a device.

3.7 Walk Test (Maintenance Password)

Select “5. Walk Test” in the screen in Fig. 3-1, and enter maintenance password. The control panel enters walk test screen, as in Fig. 3-21.

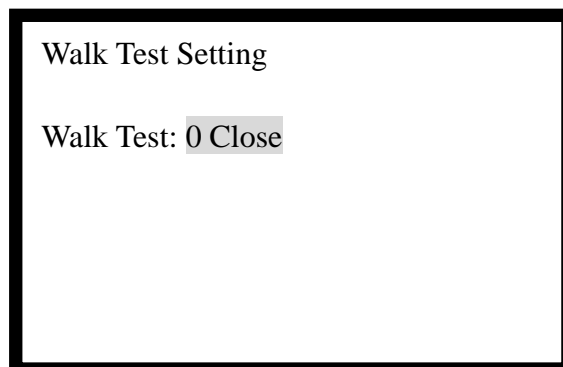
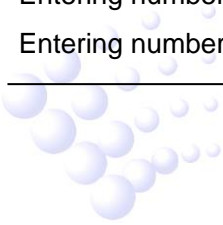

Fig. 3-21

In this screen:

Entering number “0”, “Close” is displayed to mean Non-walk test status.

Entering number “1”, “Silence” is displayed to mean “Walk Test Silence” status.



Entering number “2”, “Audible” is displayed to mean “Walk Test Audible” status.

3.8 Configure Item (Maintenance Password)

Selecting “6. Configure Item” in the screen of Fig. 3-1, the system prompts for password. Entering maintenance password, the time and LCD contrast can be set, as in Fig. 3-22.

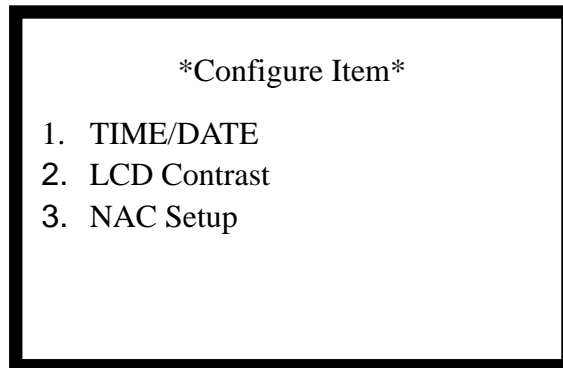

Fig. 3-22

3.8.1 TIME / DATE

Selecting “1.TIME/DATE” in the above screen can set system time as follows:

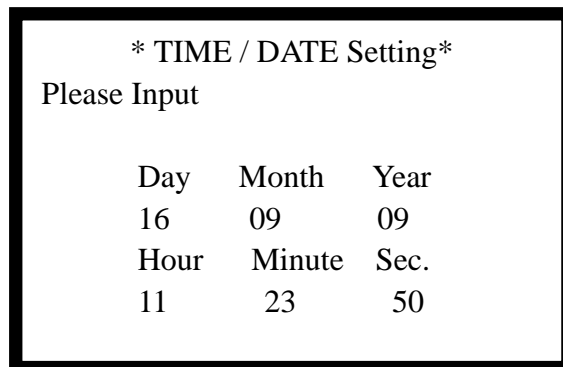

Fig. 3-23

3.8.2 LCD Contrast

Selecting “2. LCD Contrast” in the screen of Fig. 3-24 can set LCD contrast, as in the following figure:

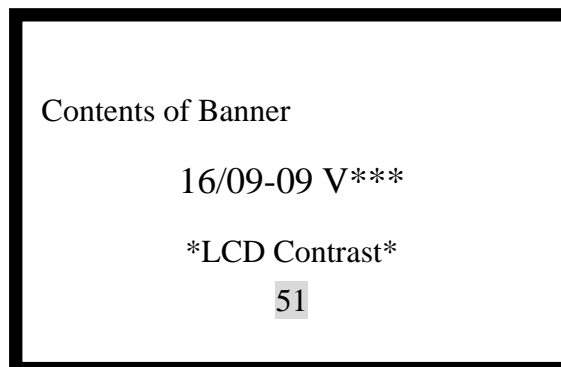
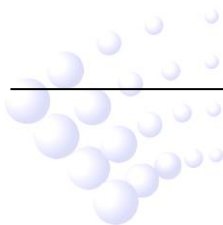

Fig. 3-24



LCD contrast can be changed by pressing the up and down key.

3.8.3 NAC Setup

Selecting “3. NAC Setup” in the screen of Fig. 3-25 can set NAC1 and NAC2, as in the following figure:

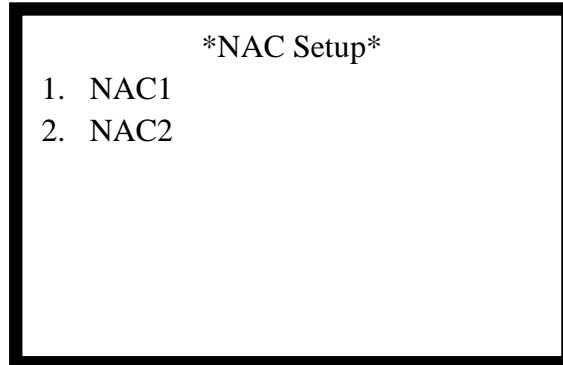

Fig. 3-25

NAC1 and NAC2 can be respectively set up with the same method. Here we take NAC1 as an example. Choosing “1. NAC1” will enter the following screen:

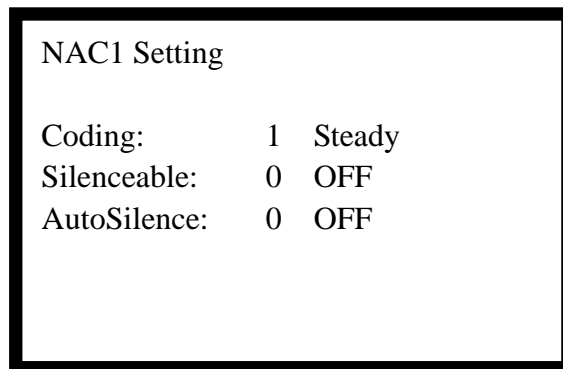

Fig. 3-26

The Coding feature allows the programmer to select the type of output that the loop interface board notification appliances will generate when activated. Four optional modes are available by selecting among number 0, 1, 2 and 3:

- 0: Disable - NAC1 is disabled.
- 1: Steady - a continuous output with no coding.
- 2: March Time - 120 ppm (pulse-per-minute) output.
- 3: Temporal - ½ second on, ½ second off, ½ second on, ½ second off, ½ second on, 1½ second off.

“Silenceable” provides options between silencing NAC1 or not. Choosing number “0”, NAC1 will not be silenced; choosing number “1”, it will be silenced.

“Auto Silence” provides options to automatically silence NAC1 or not. Number “0” means automatic silencing is not allowed, and “1” allows it to be automatically silenced.

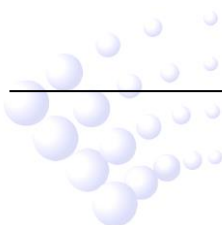

4 Operating Instructions

4.1 Panel Control Buttons

4.1.1 *ACK/STEP* (Maintenance Password)

Pressing of *ACK/STEP* will acknowledge a new fire, fault, or supervisory event. Pressing *ACK/STEP* will result in the following actions.

- ✧ Silencing the sound of this FACP.
- ✧ Lighting *ACK* LED.
- ✧ Marking an *ACK* to the event displayed.
- ✧ Writing acknowledgement record in history file.

Information of higher level will be displayed if there is more information. Pressing *ACK/STEP* repeatedly can toggle between different types of information and pressing up and down key can view them.

4.1.2 *ALARM SILENCE* (Maintenance Password)

ALARM SILENCE is used to silence the sound of the system. The following actions will be produced.

- ✧ Same effects as pressing *ACK/STEP*: Silencing the sound of panel, lighting *ACK* LED and marking an *ACK* to the event displayed.
- ✧ If an alarm exists, turn off silenceable NAC devices. Pressing *ALARM SILENCE* again can re-start the silenced device.
- ✧ *ALARM SILENCE* LED illuminates.
- ✧ Write alarm silence records to history file.
- ✧ If new alarm occurs, the silenced NAC devices will resound, and *ALARM SILENCE* LED turns off.
- ✧ *ALARM SILENCE* LED goes out after *RESET* or *DRILL/HOLD 2 SEC* key is pressed.
- ✧ The device silenced by *ALARM SILENCE* can resound automatically five minutes later.

4.1.3 *DRILL/HOLD 2 SEC* (Maintenance Password)

When the *DRILL/HOLD 2 SEC* button is held for a minimum of two seconds (time required to prevent accidental activations), the following actions will be produced.

- ✧ Turning on all silenceable NACs and control modules.
- ✧ *ALARM SILENCE* LED turns off.
- ✧ LCD displays *EVAC IN SYSTEM*.
- ✧ Writing *EVAC IN SYSTEM* records into history file.
- ✧ During *DRILL/HOLD 2 SEC* operation, pressing *ALARM SILENCE* button can turn off the NAC devices.

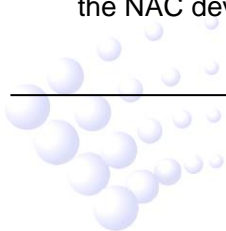

4.1.4 Reset (Maintenance Password)

Pressing and releasing the *Reset* key, the following actions will be produced.

- ✧ Turning off all the NACs and control modules.
- ✧ Resetting all loop devices.
- ✧ LCD displays *RESET IN SYSTEM*.
- ✧ Writing system reset records into history file.
- ✧ Self-testing LED, LCD and sound of the panel after resetting completed.
- ✧ Any alarm or fault that exists after reset will resound the system.

4.2 LED Indicators

The twelve LED indicators, which are located on the front panel, operate as follows:

- ✧ FIRE ALARM: Red. It lights to indicate that connected detector is in fire alarm state. If the fire alarm is cleared, pressing *RESET* will turn it off.
- ✧ ACK (Acknowledge): Yellow. When fire, trouble or supervisory message comes and acknowledged by pressing *ACK/STEP* button, it turns on. If new message comes or *RESET* is pressed, it goes off.
- ✧ SYSTEM FAULT: Yellow. It illuminates when the program fails or the system is unable to operate normally.
- ✧ POWER ON: Green. It illuminates when main or standby power is normal.
- ✧ SUPERVISORY: Yellow. It illuminates when water flow indicator is activated.
- ✧ ALARM SILENCE: Yellow. It illuminates when all external SOUNDERS are in silence state.
- ✧ GROUND FAULT: Yellow. It illuminates when all active circuits are shorted to the ground.
- ✧ BATTERY FAULT: Yellow. It illuminates when there is fault with the batteries and goes out when the fault is cleared.
- ✧ TROUBLE: Yellow. It lights to show that the FACP detects trouble on the SLC devices (detector, module) or on itself or that the FACP is in programming state. It goes out when the trouble is cleared or programming finishes.
- ✧ DISABLED: Yellow. It illuminates when there is SLC device, F.P.E output or SOUNDER output disabled.
- ✧ MAINTENANCE: Yellow. It illuminates if any smoke detector needs cleaning or the system is in programming state.
- ✧ AC FAULT: Yellow. It illuminates if AC power supply is at brownout voltage conditions. It turns off when the power supply resumes normal.

4.3 Normal Operation

With no alarm or trouble in the system, the display message is *System All Normal* along with the current time and date as shown below. To set the time and date, refer to the

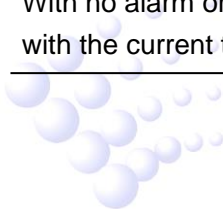

appropriate section in this manual.

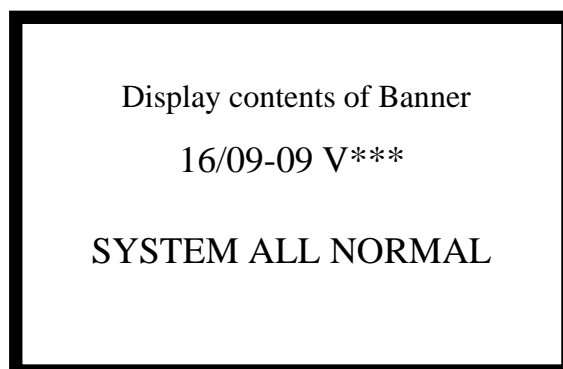

Fig. 4-1

Description:

The first line: Displaying the contents of Banner.

The second line: Displaying current date by day-month-year order and software version of the FACP.

The third line: Displaying *SYSTEM ALL NORMAL* indication.

Under normal operation, the FACP executes the following tasks regularly.

- ✧ Monitors AC input voltage and battery voltage.
- ✧ Monitors and reports status of SLC loop and the control panel.
- ✧ Polls all devices on the SLC loop and flash each device LED while checking for valid replies, alarms, troubles, etc.
- ✧ Scans control panel keypad for key presses.
- ✧ Performs self-test for all SLC devices

4.4 Trouble Operation

With no alarms in the system, the detection of a trouble will cause the following:

- ✧ The speaker of the panel pulses 1 second On and 1 second Off.
- ✧ The system *TROUBLE* LED lights.
- ✧ Devices defined as *Trouble Relay* activate.
- ✧ The word *TROUBLE* with device type, address and trouble description will appear on the LCD.
- ✧ Write history buffer.
- ✧ For messages with separate LED indication, LED and LCD indicate at the same time. But *SYSTEM FAULT* only has LED indication.
- ✧ Display for automatically reset troubles can be cleared by itself, and return to normal state.
- ✧ *SLC Line Fault* is latching signal that cannot automatically reset. It has to be reset manually.

Note that specific troubles will initiate additional actions. For example, loss of AC power

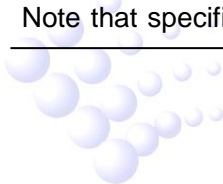

will turn on the *AC FAULT* LED, a ground fault will turn on the *GROUND FAULT* LED, etc.

For addressable devices connected to the SLC loop, the following is a typical message that could appear on the LCD display for a device trouble:

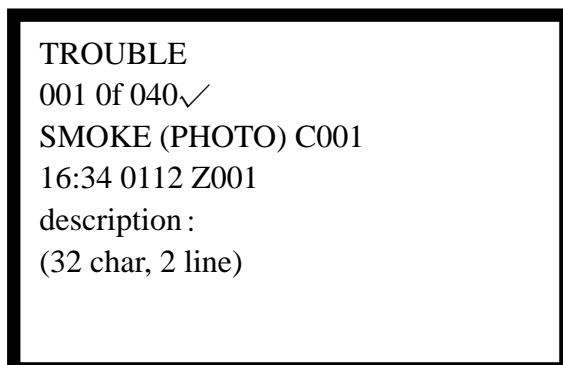

```
TRouble
001 Of 040✓
SMOKE (PHOTO) C001
16:34 0112 Z001
description :
(32 char, 2 line)
```

Fig. 4-2

Description:

- ✧ The first line: “TROUBLE” means there is trouble message.
- ✧ The second line: “001” is the number of this message, and “040” is the number of total messages. “✓” is the acknowledgement mark.
- ✧ The third line: “SMOKE (PHOTO)” is device type and “C001” is device address.
- ✧ The fourth line: “16:34 0112” is the time the event occurs in the sequence of Hour, Minute, Day, Mouth; “Z001” is the zone number.
- ✧ The fifth and sixth lines: Device description, maximum 32 characters.

4.5 Alarm Operation

Alarm operation is similar to trouble operation with the following differences:

- ✧ Devices with type number less than 12 can give alarm signal.
- ✧ Sound of the panel produces a steady output as opposed to a pulsed output.
- ✧ The *FIRE ALARM* LED turns on.
- ✧ The LCD displays *Alarm* along with the device name, type, address, associated zones and time/date.
- ✧ Alarms are self-latched and will not be cleared automatically.
- ✧ Starts the device according to the E&C equation.
- ✧ Autosilence timers are started.
- ✧ Devices defined as alarm relay are activated.
- ✧ Write history buffer.

A typical alarm display would be as illustrated below:

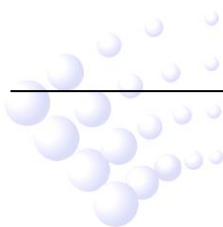

```
ALARM
001 Of 040✓
SMOKE (PHOTO) C001
16:34 0112 Z001
description :
(32 char, 2 line)
(40 char, 2 line)
```

Fig. 4-3

Description:

- ✧ The first line: ALARM means alarm message.
- ✧ The second line: “001” is the number of the message and “040” is the number of total messages. “ ✓ ” is the acknowledgement mark.
- ✧ The third line: “SMOKE (PHOTO)” is device type and “C001” is device address.
- ✧ The fourth line: “16:34 0112” is the time the event occurs in the sequence of Hour, Minute, Day, Mouth; “Z001” is the zone number.
- ✧ The fifth and sixth line: Device description, maximum 32 characters.

4.6 Waterflow Circuits Operation (For Future Use)

Only the device whose type is 11 can carry out Waterflow Circuits operation. Its operating method is the same as *4.5 Alarm Operation*.

4.7 Supervisory Operation

The devices whose types are between 11 and 19 can carry out supervisory operation, which is similar to alarm operation excluding the following difference.

- ✧ Sound of the panel pulses $\frac{1}{2}$ second On and $\frac{1}{2}$ second Off.
- ✧ The *SUPERVISORY* LED turns on.
- ✧ The LCD displays the status label *Active Supervisory* along with the device name, type, address, associated zones and time/date.
- ✧ The device defined as supervisory relay is activated.
- ✧ Silenced alarms resound.
- ✧ Autosilence timer is not started.
- ✧ Write history buffer.

A typical Supervisory event would be displayed as follows:

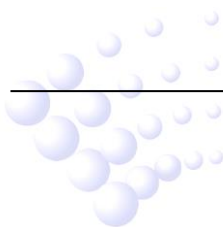

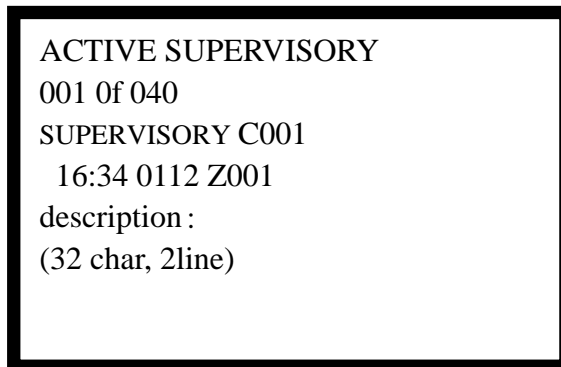

```
ACTIVE SUPERVISORY
001 Of 040
SUPERVISORY C001
  16:34 0112 Z001
description :
(32 char, 2line)
```

Fig. 4-4

Description:

- ✧ The first line: "ACTIVE SUPERVISORY" means supervisory message.
- ✧ The second line: "001" is the number of the message and "040" is the number of total messages.
- ✧ The third line: "SUPERVISORY" is the device type and "C001" is device address.
- ✧ The fourth line: "16:34 0112" is the time the event occurs in the sequence of Hour, Minute, Day, Mouth; "Z001" is the zone number.
- ✧ The fifth and sixth lines: Device description, maximum 32 characters.

4.8 Coded Operation

The NAC circuits on the control panel loop interface board can be programmed for coded operation. The available pulse rates which can be programmed for coded operation are as follows:

- ✧ Steady - a continuous output with no coding.
- ✧ Temporal - ½ second on, ½ second off, ½ second on, ½ second off, ½ second on, 1½ second off.

4.9 Positive Alarm Sequence

PAS (Positive Alarm Sequence) procedure: When a detector alarms, sound indication of the panel can be started immediately and PAS Relay devices are activated. NACs will not be activated within 15 seconds. Pressing *ALARM SILENCE* or *ACK/STEP* key within this period, local sound will be silenced and the second period of delay will start. The second period can be programmed up to 3 minutes. At the end of the second delay period, if fire alarm is not cleared, NACs will be activated. If the second alarm occurs during any delay period, the delay will stop and NACs and/or control modules will be immediately activated. PAS will activate the following:

- ✧ Immediately start sound indication.
- ✧ PAS relay devices are activated.
- ✧ NACs will not be activated within 15 seconds. Pressing *ALARM SILENCE* or *ACK/STEP* key within this period, local sound will be silenced and the second period

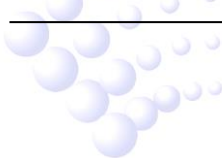

of delay will start. The second period can be programmed up to 3 minutes. At the end of the second delay period, if fire alarm is not cleared, NACs will be activated.

- ✧ If the second alarm occurs during any delay period, the delay will stop and NACs and/or control modules will be immediately activated.
- ✧ PAS does not affect waterflow indicators and supervisory devices.
- ✧ Action of PAS BYPASS devices will disable PAS until they reset. The panel will transfer from PAS condition to alarm condition immediately by pressing a pull station during PAS delay time. A pull station shall be installed next to the FACP.

4.10 Walk Test

Walk test is a feature which allows one person to test the fire alarm system. During audible walk test, the NACs will output for a moment and record the test information. During silence walk test, the NACs will not output, but only record the test information. Disabled devices will not be activated during walk test.

Alarm test: During audible walk test, each new alarm will activate the NACs and associated modules for 3~4 seconds, the walk test of these devices shall be set to ON. The LCD will display the alarm events, which will be marked with the word *walk test* to distinguish with normal events. If there are no new messages in 30 minutes, the FACP exits walk test status. During walk test, if real fire or fault happens, the LCD will clear walk test message and show the real one.

4.11 Read Status

In the screen shown in Fig. 3-1, selecting “1. Read Status” can view history records, device information, E&C, network FACPs and disabled devices, as shown in Fig. 4-5.

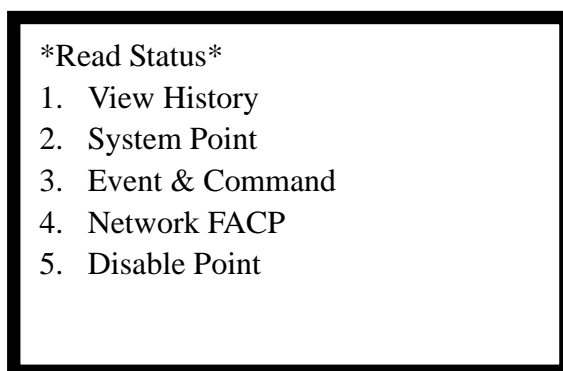
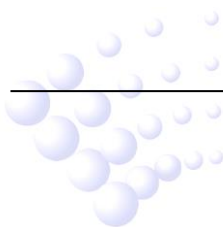

Fig. 4-5

4.11.1 View History

Selecting “1. View History” in the screen of Fig. 4-5 can view history records, as shown in Fig. 4-6.



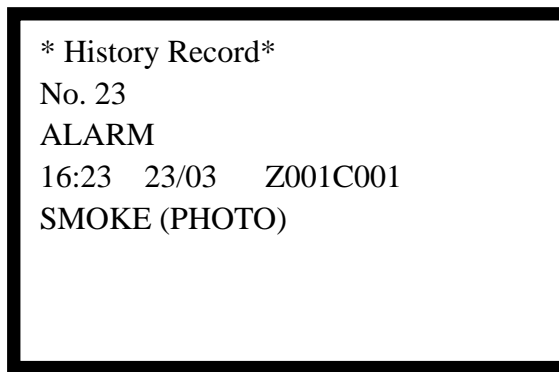

Fig. 4-6

Description:

The number and type of records can be displayed here, with their time, date, zone, device code and device type.

4.11.2 System Point

Selecting “2. System Point” in the screen of Fig. 4-5 can view device information, as in Fig. 4-7.

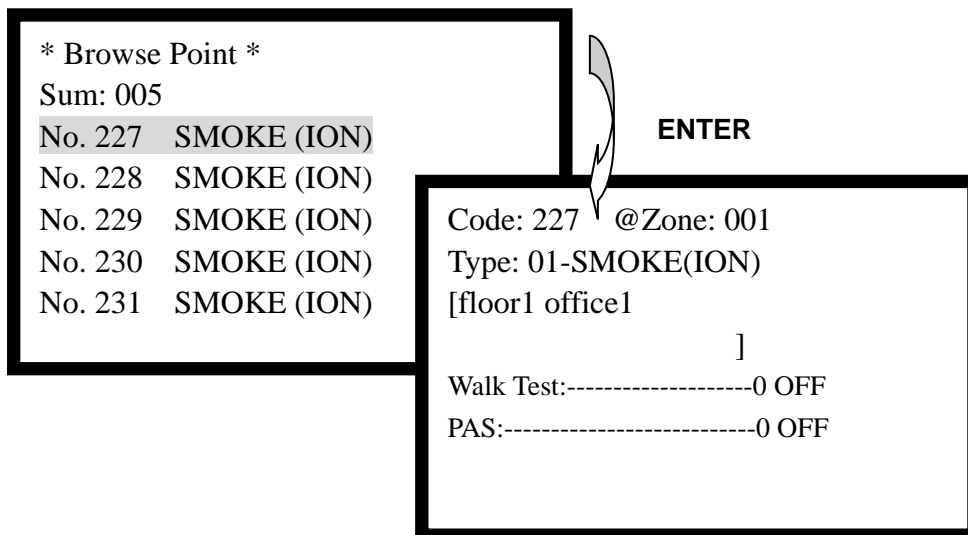
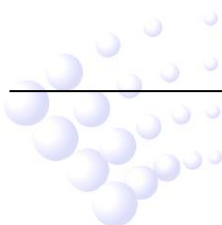

Fig. 4-7

Selecting a device message using the up and down key and pressing *ENTER*, detailed definition information of the device can be viewed.

4.11.3 Event & Command

Selecting “3. Event & Command” in the screen of 4-5 can view E&C information, as in Fig. 4-8.



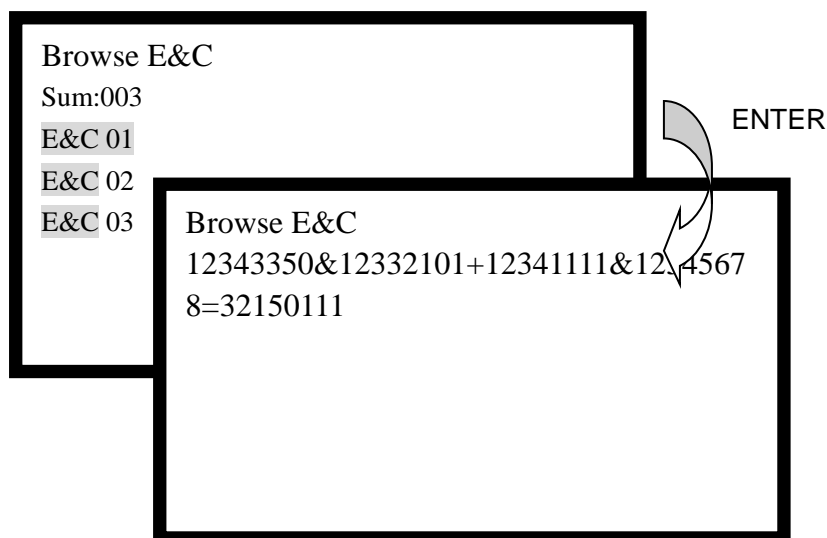

Fig. 4-8

4.11.4 Disable Point

Selecting “5. Disable Point” in the screen of Fig. 4-5 can view information of disabled devices.

5 Selecting and Locating Batteries

5.1 NFPA Battery Requirements

NFPA 72 Local and Proprietary Fire Alarm Systems require 24 hours of standby power followed by 5 minutes in alarm.

5.2 Calculating the Battery Size

The size of batteries needed for a system can be calculated according to the following tables.

Table 5-1

Device	Current	
	Standby Current Number x Ij = Total	Alarm Current Number x Ia = Total
GST-M200	1 x 0.34A = 0.34A	1 x 0.45A = 0.45A
Smoke detector I-9102(UL) / JTY-GD-G3	N x 0.0008A =	N x 0.002A =
Heat detector I-9103(UL) / JTY-ZCD-G3N	N x 0.0008A =	N x 0.002A =
Loop isolator C-9503 / GST-LD-8322	N x 0.005A =	N x 0.005A =
Input module I-M9300 / GST-LD-8300	N x 0.001A =	N x 0.003A =
Output module I-M9301 / GST-LD-8301	N x 0.001A =	N x 0.003A =
LC200 Loop card	1 x 0.135A = 0.135A	1 x 0.135A = 0.135A

P-9930 Ancillary device	$1 \times 0.05A = 0.05A$	$1 \times 0.05A = 0.05A$
P-M9930 Modbus card	$1 \times 0.05A = 0.05A$	$1 \times 0.1A = 0.05A$
P-M9960A network card	$1 \times 0.05A = 0.05A$	$1 \times 0.11A = 0.05A$
Loop isolator C-M9503	$N \times 0.0015A =$	$N \times 0.002A =$
Heat Photoelectric Smoke Detector DI-M9101	$N \times 0.0008A =$	$N \times 0.0018A =$ (without remote indicator) $N \times 0.0018A =$ (with remote indicator)
Photoelectric Smoke Detector DI-M9102	$N \times 0.0008A =$	$N \times 0.0018A =$ (without remote indicator) $N \times 0.0018A =$ (with remote indicator)
Intelligent Rate of Rise and Fixed Temperature Heat Detector DI-M9103	$N \times 0.0006A =$	$N \times 0.0015A =$ (without remote indicator) $N \times 0.0035A =$ (with remote indicator)
Total	Total standby current	Total alarm current

Table 5-2

System Status	Battery requirement (Unit: Ah)
Required standby time T_j (hour)	Total standby current $\times T_j$
Required alarm time T_a (hour)	Total alarm current $\times T_a$
Work time for maximum load T_w (hour)	$4.3A$ (maximum load current) $\times T_w$
Total	The sum of the above three items is the maximum battery capacity required by the FACP.

Please select batteries that meet or exceed the total ampere hours calculated in Table 5-1 and 5-2. The control panel can charge batteries less than 20Ah. Batteries larger than 20Ah require a UL listed external battery charger.

Note: When batteries over 20Ah are used, they should be put into a separate battery box, which is not provided. The battery box must be located in the same room with the fire alarm control panel.

6 Default Programming

Program Option	Factory Default
BANNER	GST CO., LTD.
Maintenance Password	Empty
Master Password	11111111
PAS Timer	0
Userwords	Undefined
Userdefine	Userdefine01-15
E&C	Undefined
Device address (1-242)	Zone: 001 Type: 0 Undefined Walktest: on PAS: off Silenceable: on Autosilence: off
Walk Test	Off

7 Wire Requirements

CIRCUIT CONNECTIONS		WIRE REQUIREMENTS		
Circuit Type	Circuit Function	Wire Type and Limitations	Recommended Max. Distance Feet (meters)	Wire Gauge
SLC loop (power-limited)	Connects to addressable devices	Twisted pair	Max. Distance is limited by the loop current. e.g. max. 4000ft (1200 m) for 70 mA loop current; max.1310 ft (400 m) for 200 mA loop current.	17AWG (1.0mm ²)
NAC#1 (power-limited)	Connects to conventional sounder strobes	In alarm, no more than a 2.0V drop allowed at end of circuit.	Distance limitation set by 2.0V maximum line drop.	18AWG (0.78mm ²)
24VDC (power-limited)	Powering modules	No more than 2.0V drop allowed from supply source to end of any branch.	Distance limitation set by 2.0V maximum line drop.	18AWG (0.78mm ²)

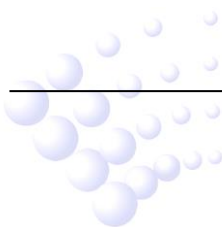

8 Menu Operation Guide

MODE

- 1. READ STATUS
 - 1. VIEW HISTORY
 - 2. SYSTEM POINT
 - 3. EVENT&COMMAND
 - 4. NETWORK FACP
 - 5. DISABLE POINT
- 2 PROGRAMMING [Master Password Required]
 - 1. POINT DEBUG
 - 2. POINT EDIT
 - 3. NETWORK SETUP (For Future Use)
 - 1. NETWORK LOCAL ADDRESS
 - 2. EVENT DISPLAY MODE
 - 3. NETWORK FACP NAME
 - 4. REPEATER NAME
 - 4. EVENT&COMMAND
 - 1. EDIT E&C
 - 2. DELETE E&C
 - 5. SYSTEM SETUP
 - 1. CLEAR PROGRAM
 - 2. BANNER
 - 3. PASSWORD CHANGE
 - 4. TIMERS
 - 1. PAS DELAY
 - 5. DEFINED SLC TYPE
 - 6. MY WORDS
- 3. AUTOPROGRAM [Maintenance Password Required]
- 4. DISABLE / ENABLE [Maintenance Password Required]
 - 1. DISABLE EQ
 - 2. ENABLE EQ
- 5. WALK TEST [Maintenance Password Required]
- 6. CONFIGURE ITEM [Maintenance Password Required]
 - 1. TIME/DATE
 - 2. LCD CONTRAST
 - 3. NAC SETUP
 - 1. NAC1
 - 2. NAC2

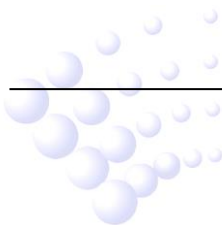



Limited Warranty

The manufacturer warrants its products to be free from defects in materials and workmanship for 2 years from the date of manufacture, under normal use and service. Products are date-stamped at time of manufacture. The sole and exclusive obligation of the manufacturer is to repair or replace, at its option, free of charge for parts and labor, any part which is defective in materials or workmanship under normal use and service. For products not under the manufacturer's date-stamp control, the warranty is 2 years from date of original purchase by the manufacturer's distributor unless the installation instructions or catalog sets forth a shorter period, in which case the shorter period shall apply. This warranty is void if the product is altered, repaired, or serviced by anyone other than the manufacturer or its authorized distributors, or if there is a failure to maintain the products and systems in which they operate in a proper and workable manner. In case of defect, secure a Return Material Authorization form from our customer service department. Return product, transportation prepaid, to the manufacturer.

This writing constitutes the only warranty made by this manufacturer with respect to its products. The manufacturer does not represent that its products will prevent any loss by fire or otherwise, or that its products will in all cases provide the protection for which they are installed or intended. Buyer acknowledges that the manufacturer is not an insurer and assumes no risk for loss or damages or the cost of any inconvenience, transportation, damage, misuse, abuse, accident, or similar incident.

THE MANUFACTURER GIVES NO WARRANTY, EXPRESSED OR IMPLIED, OF MERCHANTABILITY, FITNESS FOR ANY PARTICULAR PURPOSE, OR OTHERWISE WHICH EXTEND BEYOND THE DESCRIPTION ON THE FACE HEREOF. UNDER NO CIRCUMSTANCES SHALL THE MANUFACTURER BE LIABLE FOR ANY LOSS OF OR DAMAGE TO PROPERTY, DIRECT, INCIDENTAL, OR CONSEQUENTIAL, ARISING OUT OF THE USE OF, OR INABILITY TO USE THE MANUFACTURER'S PRODUCTS. FURTHERMORE, THE MANUFACTURER SHALL NOT BE LIABLE FOR ANY PERSONAL INJURY OR DEATH WHICH MAY ARISE IN THE COURSE OF, OR AS A RESULT OF, PERSONAL, COMMERCIAL, OR INDUSTRIAL USE OF ITS PRODUCTS.

This warranty replaces all previous warranties and is the only warranty made by the manufacturer. No increase or alteration, written or verbal, of the obligation of this warranty is authorized.

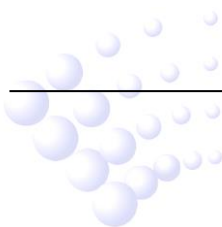

Appendix Basic System Connection

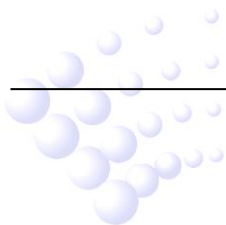
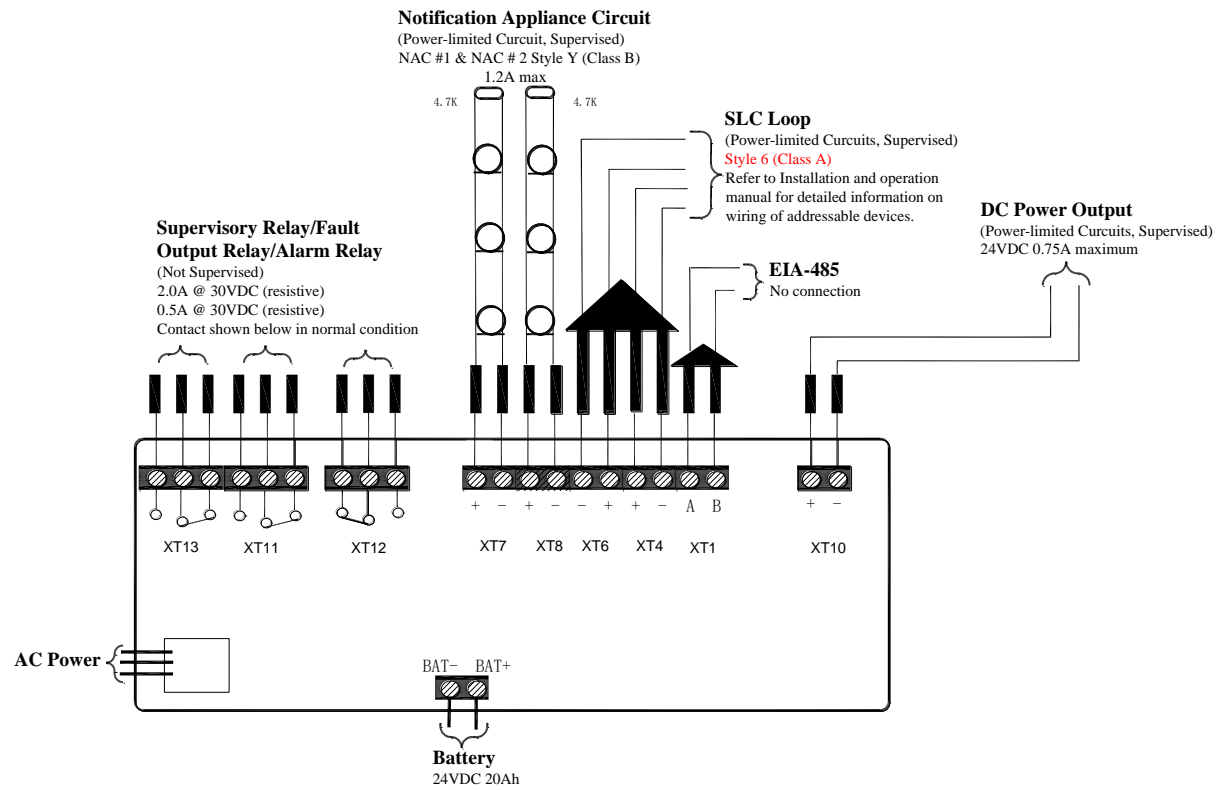



[Gulf Security Technology Co., Ltd.](#)

No. 80, Changjiang East Road, QETDZ, Qinhuangdao, Hebei,

P. R. China 066004

Tel: +86 (0) 335 8502434

Fax: +86 (0) 335 8502532

service.gst@fs.utc.com

www.gst.com.cn